

ACE



Basic Pedestal Standard Centrifugal Pump Model VG1 1/2D3-B Size 2 1/2" x 1 1/2"

PUMP SPECIFICATIONS

- Size:** 2 1/2" x 1 1/2" (64 mm x 38 mm) Flanged.
- Casing:** Gray Iron 40.
Maximum Operating Pressure 241 psi (1662 kPa).*
- Enclosed Type, Six Vane Impeller:** Gray Iron 40.
Handles 5/16" (7,9 mm) Diameter Spherical Solids.
- Impeller Shaft:** Steel 1045.
- Shaft Sleeve:** Stainless Steel 420.
- Seal Plate:** Gray Iron 40.
- Bearing Housing:** Gray Iron 40.
- Radial Bearing:** Open Single Row Ball.
- Thrust Bearing:** Open Double Row Ball.
- Bearing Lubrication:** SAE 30 Non-Detergent Oil.
- Gaskets:** Nitrile Rubber.
- O-Ring:** Fluorocarbon (DuPont Viton® or Equivalent).
- Hardware:** Standard Plated Steel.
- Oil Level Sight Gauge.**

Optional Equipment: NPT Suction and Discharge Flanges. Strainer. Stainless Steel Impeller. Mechanical Seal with Fluorocarbon Elastomers (DuPont Viton® or Equivalent).

**Consult Factory for Applications Exceeding Maximum Pressure and/or Temperature Indicated.*

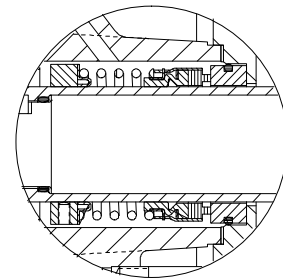
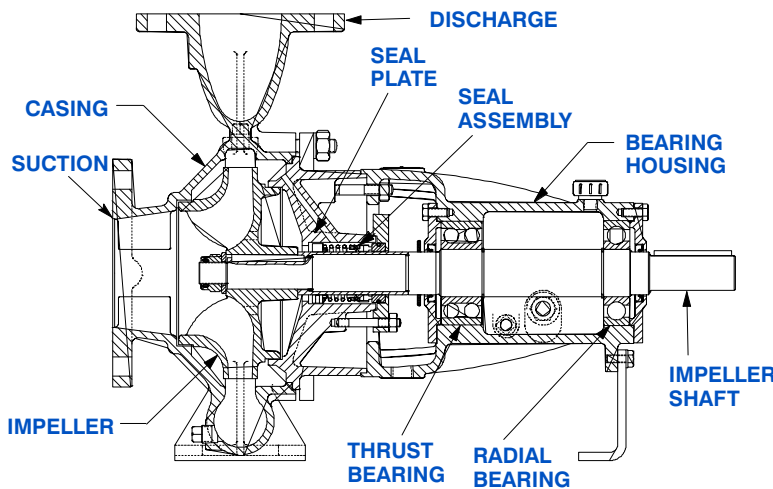
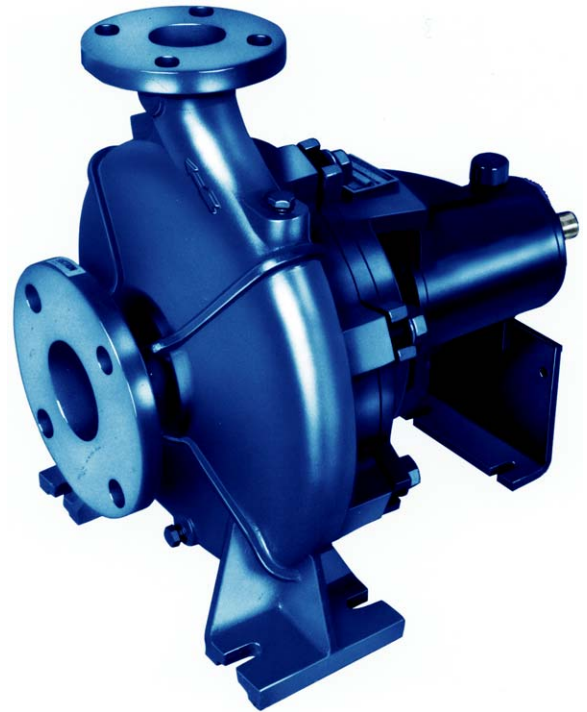

SEAL DETAIL

Type 1, Mechanical, Self-Lubricated. Carbon Rotating Face. Ceramic Stationary Seat. Buna-N Elastomers. Stainless Steel and/or Brass Cage and Spring. Maximum Temperature of Liquid Pumped, 160°F (71°C).*



THE GORMAN-RUPP COMPANY • MANSFIELD, OHIO
GORMAN-RUPP OF CANADA LIMITED • ST. THOMAS, ONTARIO, CANADA

www.grpumps.com

Specifications Subject to Change Without Notice

Printed in U.S.A.

Specification Data

SECTION 70, PAGE 160

APPROXIMATE DIMENSIONS and WEIGHTS

NET WEIGHT:

107 LBS. (48,5 KG.)

SHIPPING WEIGHT:

117 LBS. (53,1 KG.)

EXPORT CRATE SIZE:

5.6 CU. FT. (0,16 CU. M.)

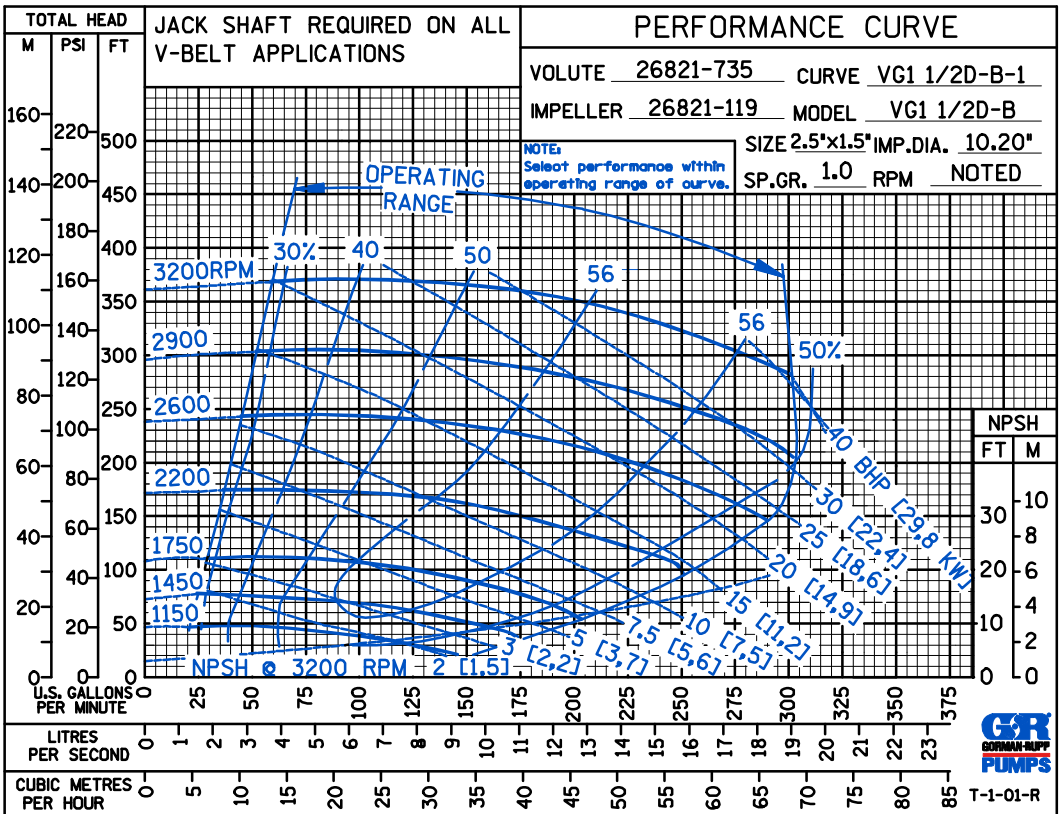
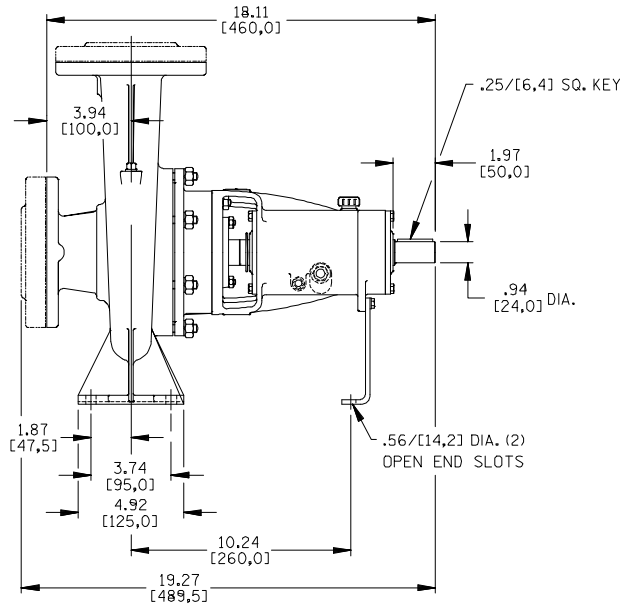
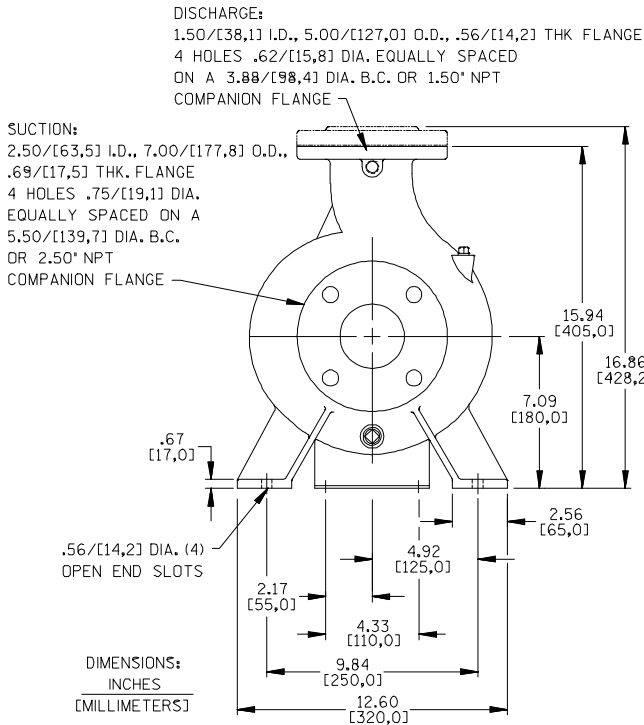

THE GORMAN-RUPP COMPANY • MANSFIELD, OHIO

GORMAN-RUPP OF CANADA LIMITED • ST. THOMAS, ONTARIO, CANADA

Specifications Subject to Change Without Notice

Printed in U.S.A.

ACE

PERFORMANCE
BASED ON
WATER

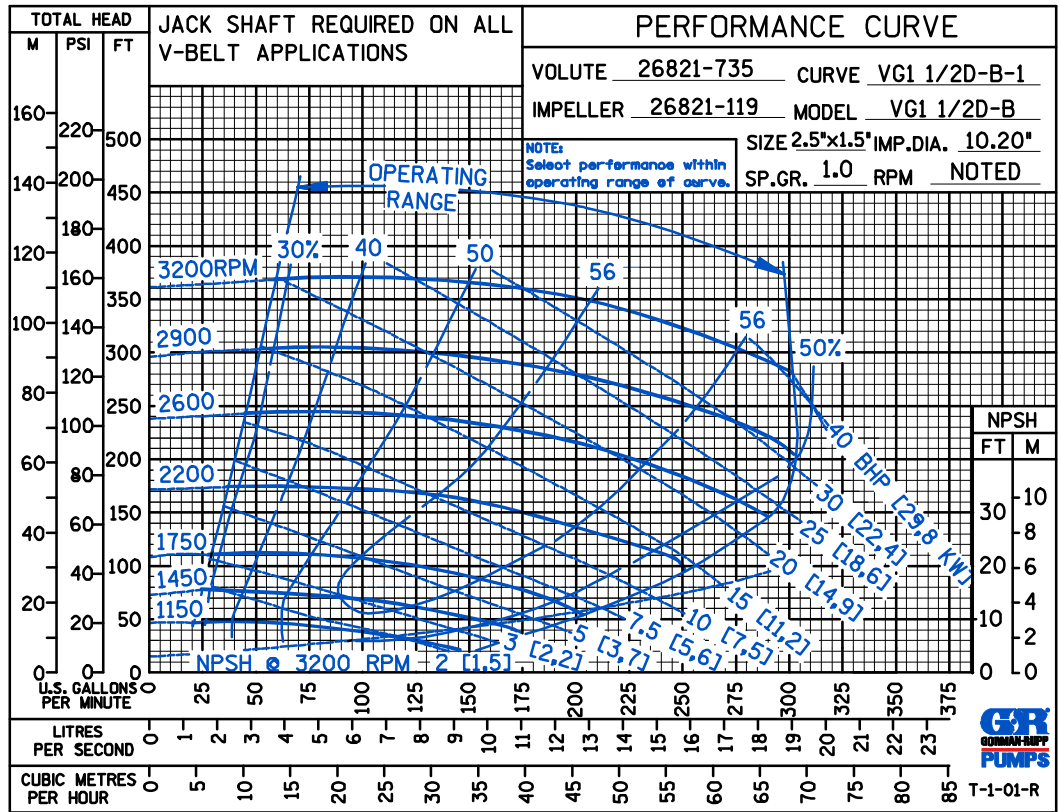

PERFORMANCE
BASED ON
WATER

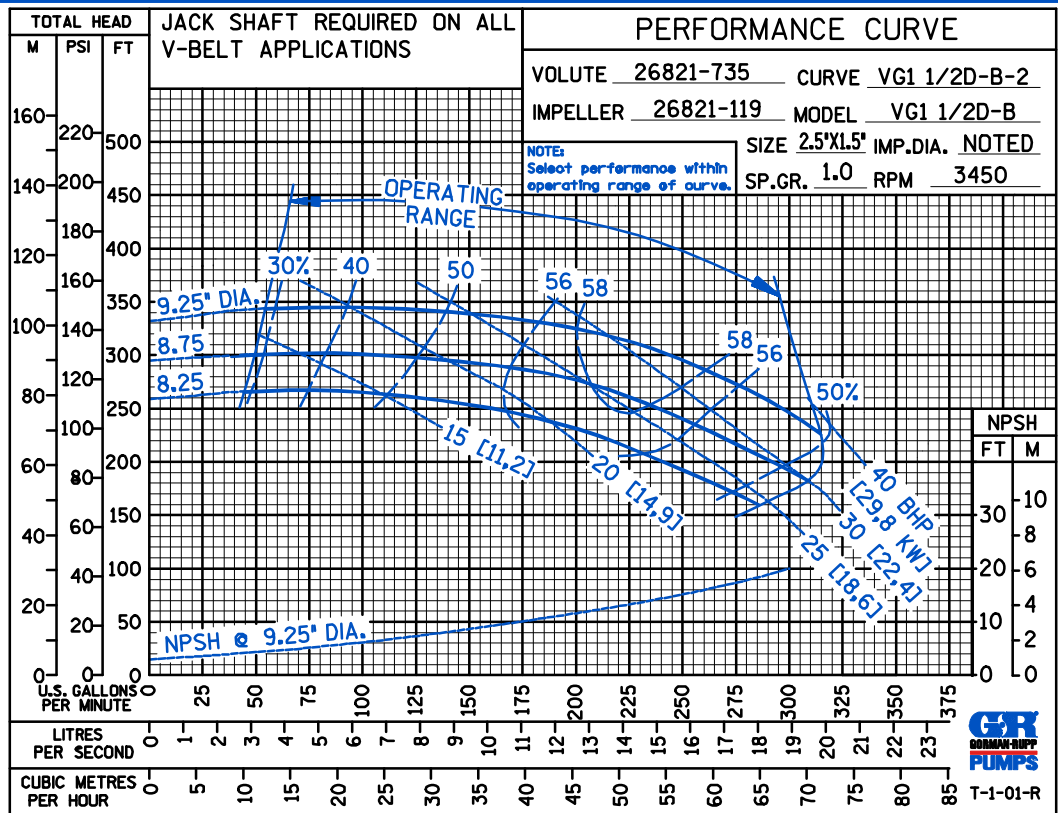

THE GORMAN-RUPP COMPANY • MANSFIELD, OHIO

GORMAN-RUPP OF CANADA LIMITED • ST. THOMAS, ONTARIO, CANADA

Specifications Subject to Change Without Notice

Printed in U.S.A.

ACE

PERFORMANCE
BASED ON
WATER

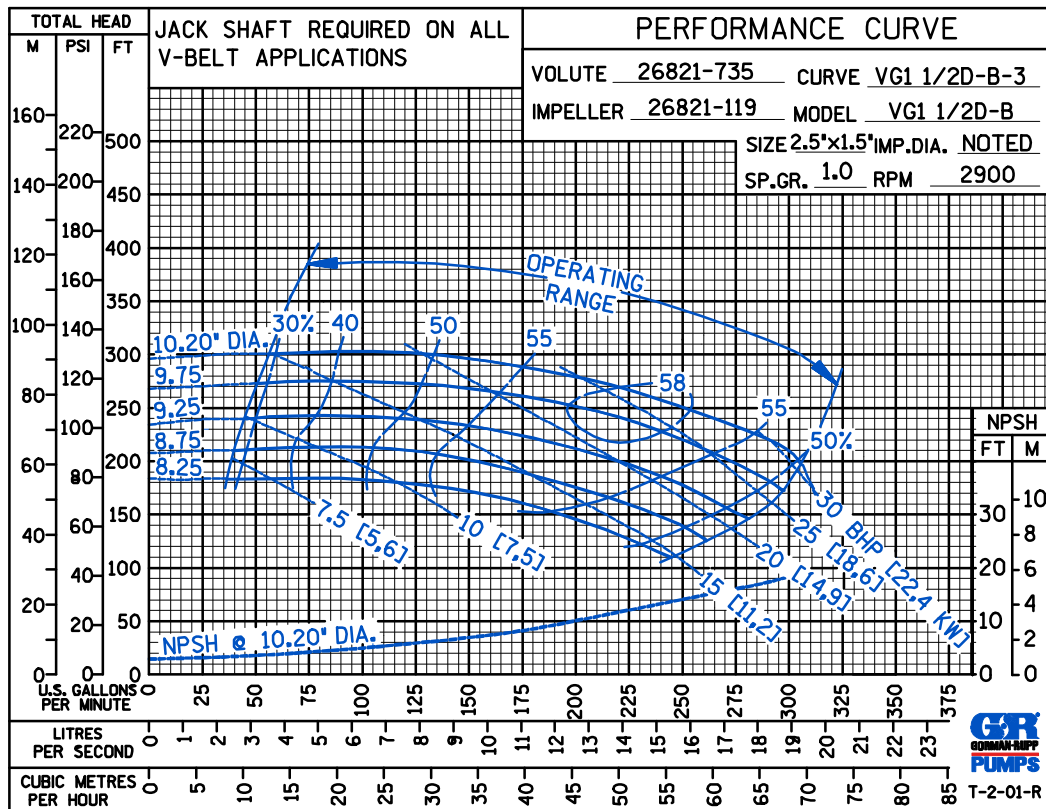

PERFORMANCE
BASED ON
WATER

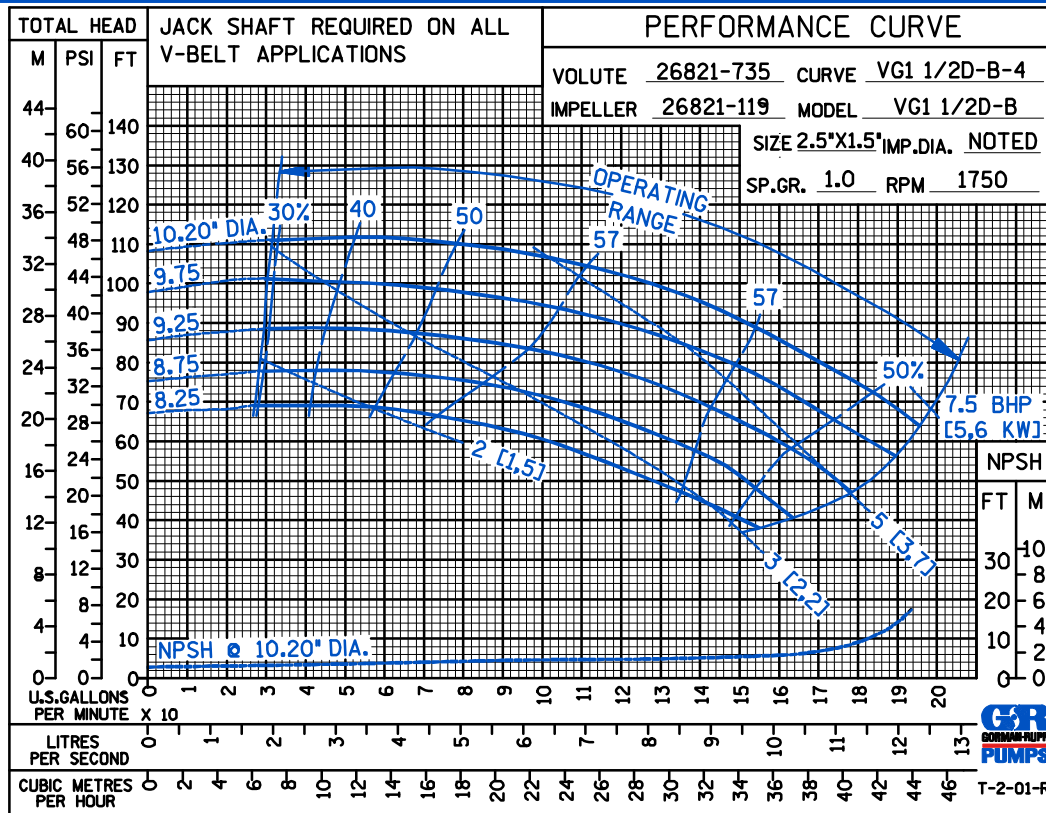

THE GORMAN-RUPP COMPANY • MANSFIELD, OHIO

GORMAN-RUPP OF CANADA LIMITED • ST. THOMAS, ONTARIO, CANADA

Specifications Subject to Change Without Notice

Printed in U.S.A.

ACE

PERFORMANCE
BASED ON
WATER

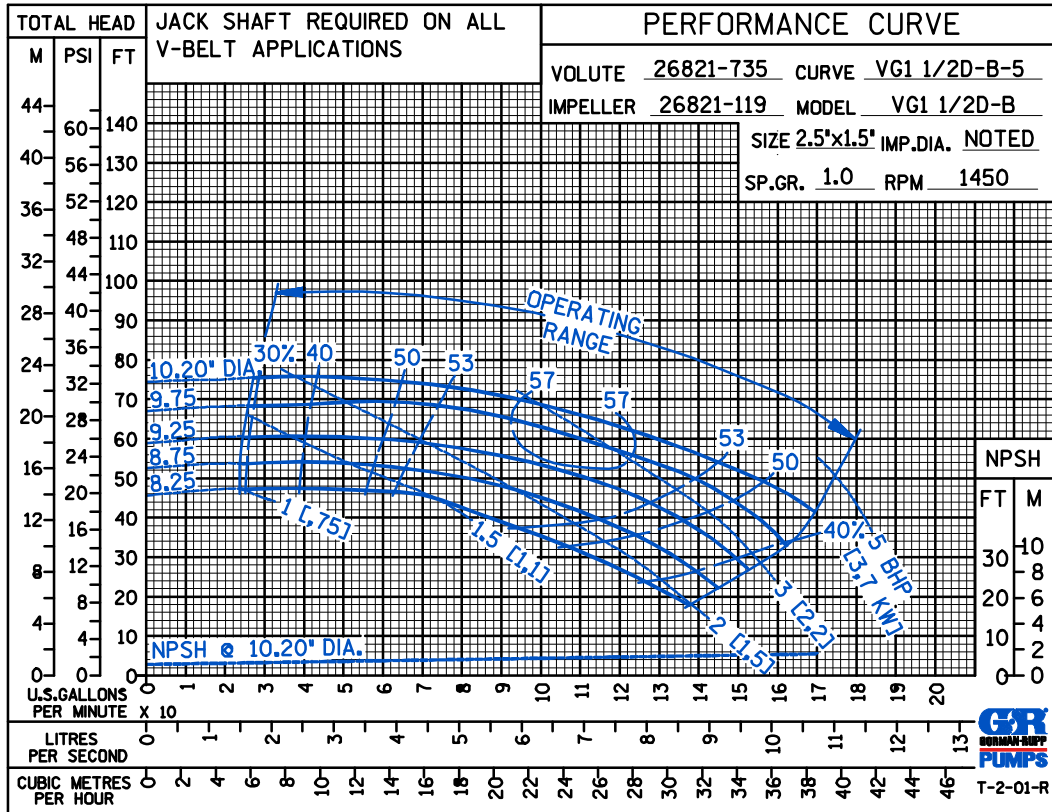

PERFORMANCE
BASED ON
WATER

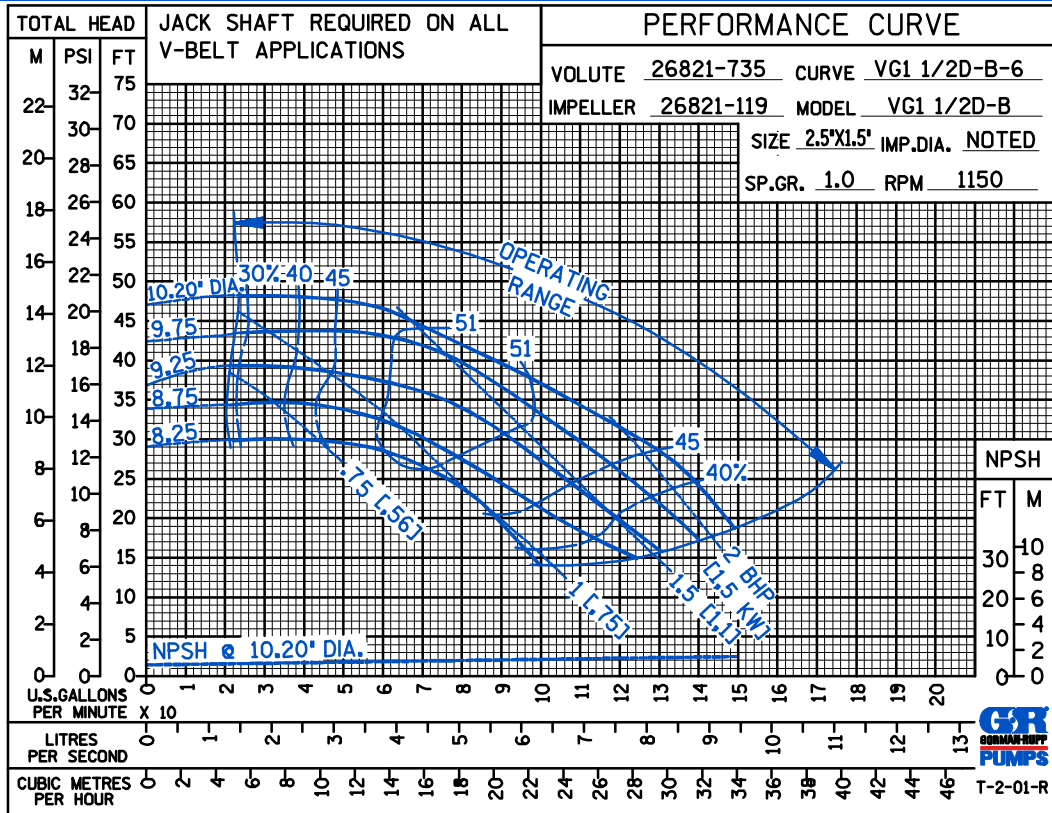

THE GORMAN-RUPP COMPANY • MANSFIELD, OHIO

GORMAN-RUPP OF CANADA LIMITED • ST. THOMAS, ONTARIO, CANADA

Specifications Subject to Change Without Notice

Printed in U.S.A.

ACE

PERFORMANCE
BASED ON
PETROLEUM

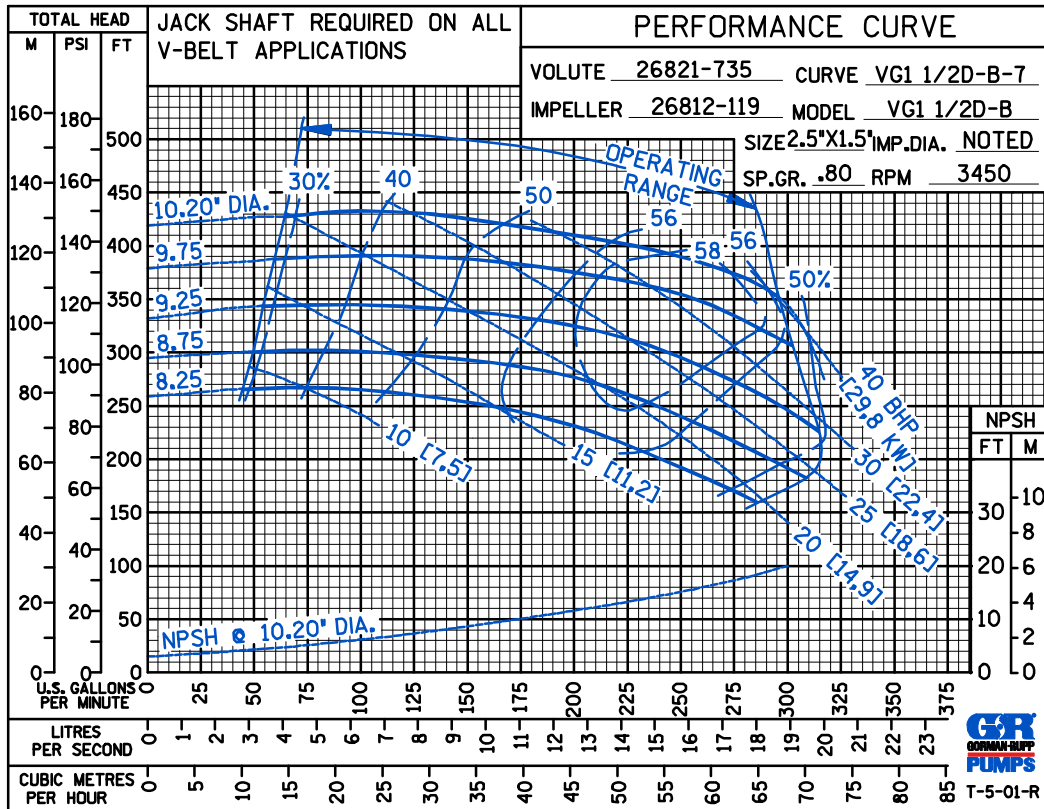

PERFORMANCE
BASED ON
PETROLEUM

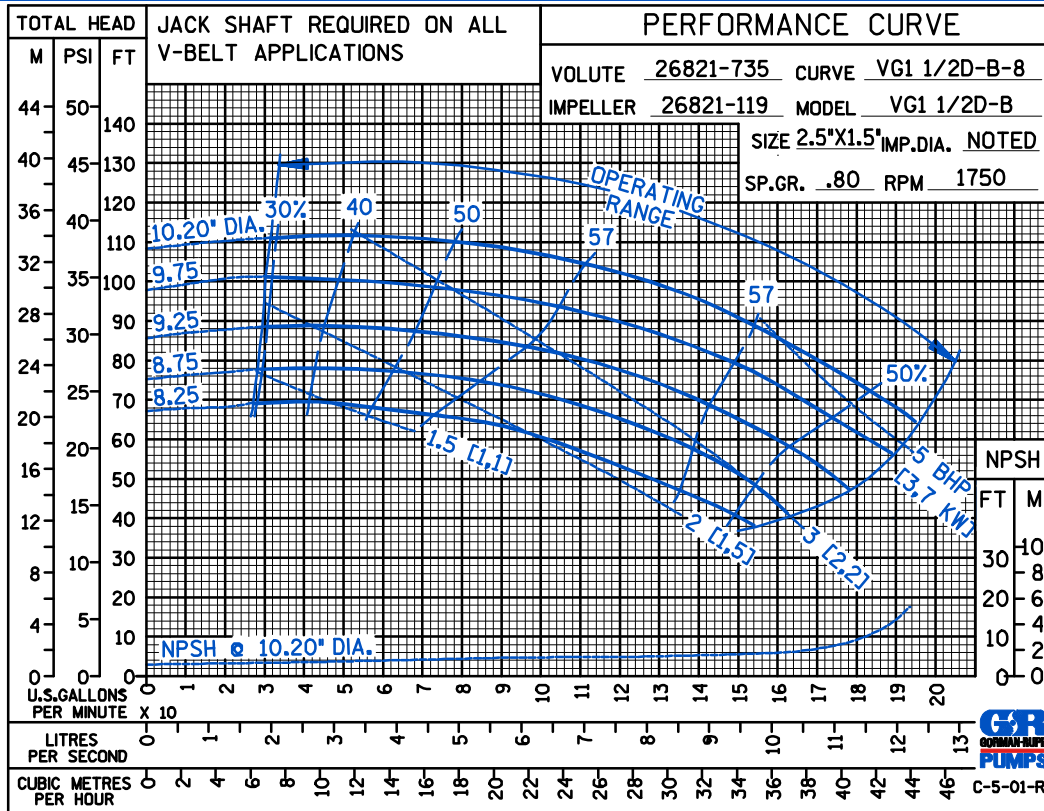

THE GORMAN-RUPP COMPANY • MANSFIELD, OHIO

GORMAN-RUPP OF CANADA LIMITED • ST. THOMAS, ONTARIO, CANADA

Specifications Subject to Change Without Notice

Printed in U.S.A.