

Stainless Steel Fitted Basic Pump



Self Priming Centrifugal Pump

Model T2A61-B

Size 2" x 2"

VARIOUS PATENTS APPLY

PUMP SPECIFICATIONS

Size: 2" x 2" (51 mm x 51 mm) NPT - Female.**Casing:** Gray Iron 30.

Maximum Operating Pressure 79 psi (545 kPa).*

Semi-Open Type, Two Vane Impeller: Stainless Steel 316.

Handles 1 1/2" (38,1 mm) Diameter Spherical Solids.

Impeller Shaft: Stainless Steel 17-4 PH.**Shaft Sleeve:** Stainless Steel 316.**Replaceable Wear Plate:** Stainless Steel 316.**Removable Cover Plate:** Gray Iron 30; 20 lbs. (9 kg).**Seal Plate:** Stainless Steel 316.**Externally Replaceable Flap Valve:** Neoprene w/Steel Reinforcing.**Bearing Housing:** Gray Iron 30.**Radial Bearing:** Open Single Row Ball.**Thrust Bearing:** Open Double Row Ball.**Bearing and Seal Cavity Lubrication:** SAE 30 Non-Detergent Oil.**Suction Flange:** 125# Gray Iron 30.**Discharge Flange:** 150# Steel.**Gaskets:** Buna-N, Vegetable Fiber, Cork and Rubber.**O-Rings:** Buna-N.**Internal Wetted Hardware:** Stainless Steel 316.**External Hardware:** Standard Plated Steel.**Stainless Steel 316 Pressure Relief Valve.****Bearing and Seal Cavity Oil Level Sight Gauges.****Optional Equipment:** Automatic Air Release Valve. 120V/240V

Casing Heater. High Pump Temperature Shutdown Kit.

CD4MCu Stainless Steel Seal Plate, Wear Plate and Impeller.

Self-Cleaning Wear Plate.

Gray Iron 30 Suction and Discharge Spool Flanges:

2" ASA.

50 mm DIN 2527 (PN 16).

Consult Factory for Applications Exceeding Maximum Pressure and/or Temperature Indicated.*Shown with Optional Suction & Discharge Spool Flanges (Available in ASA or DIN Standard Sizes).**

SEAL SPECIFICATIONS

Mechanical, Oil-Lubricated, Double Floating, Self-Aligning. Silicon Carbide Rotating and Stationary Faces. Stainless Steel 316 Stationary Seat. Fluorocarbon Elastomers (DuPont Viton® or Equivalent). Stainless Steel 18-8 Cage and Spring. Maximum Temperature of Liquid Pumped, 160°F (71°C).*

SEAL DETAIL

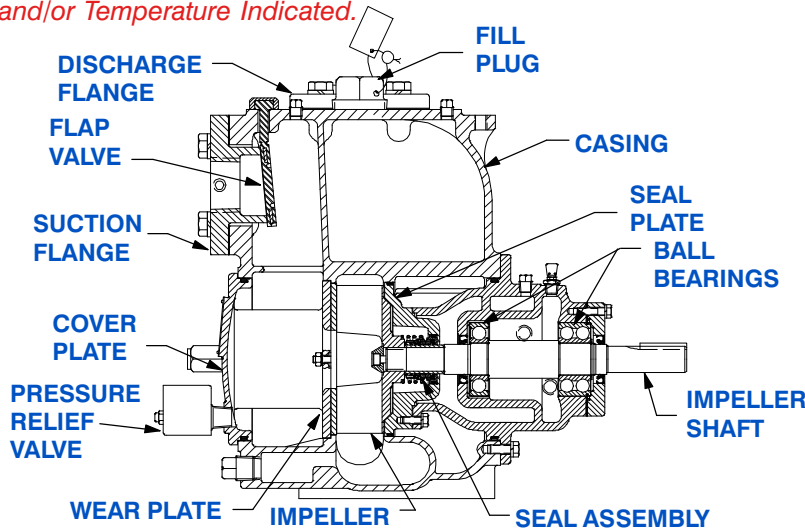
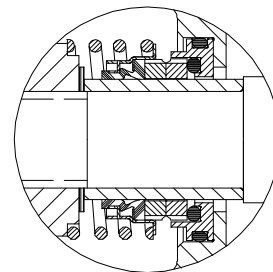

THE GORMAN-RUPP COMPANY • MANSFIELD, OHIO

GORMAN-RUPP OF CANADA LIMITED • ST. THOMAS, ONTARIO, CANADA

www.grpumps.com

Specifications Subject to Change Without Notice

Printed in U.S.A.

Specification Data

SECTION 55, PAGE 986

APPROXIMATE DIMENSIONS and WEIGHTS

NET WEIGHT: 220 LBS. (100 KG.)*
SHIPPING WEIGHT: 230 LBS. (104 KG.)*
EXPORT CRATE: 7.9 CU. FT. (0,22 CU. M.)
***ADD 8 LBS. (3,6 KG.) W/EACH SPOOL FLANGE**

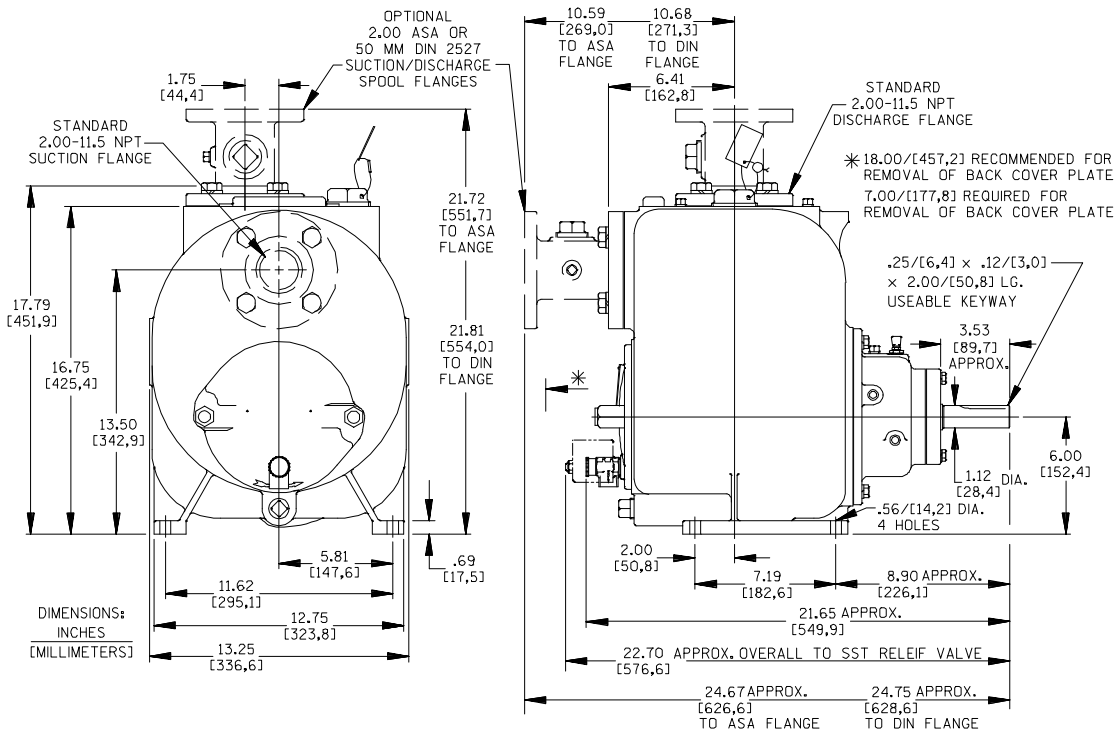

OPTIONAL ASA OR DIN STANDARD SUCTION & DISCHARGE SPOOL FLANGES AVAILABLE

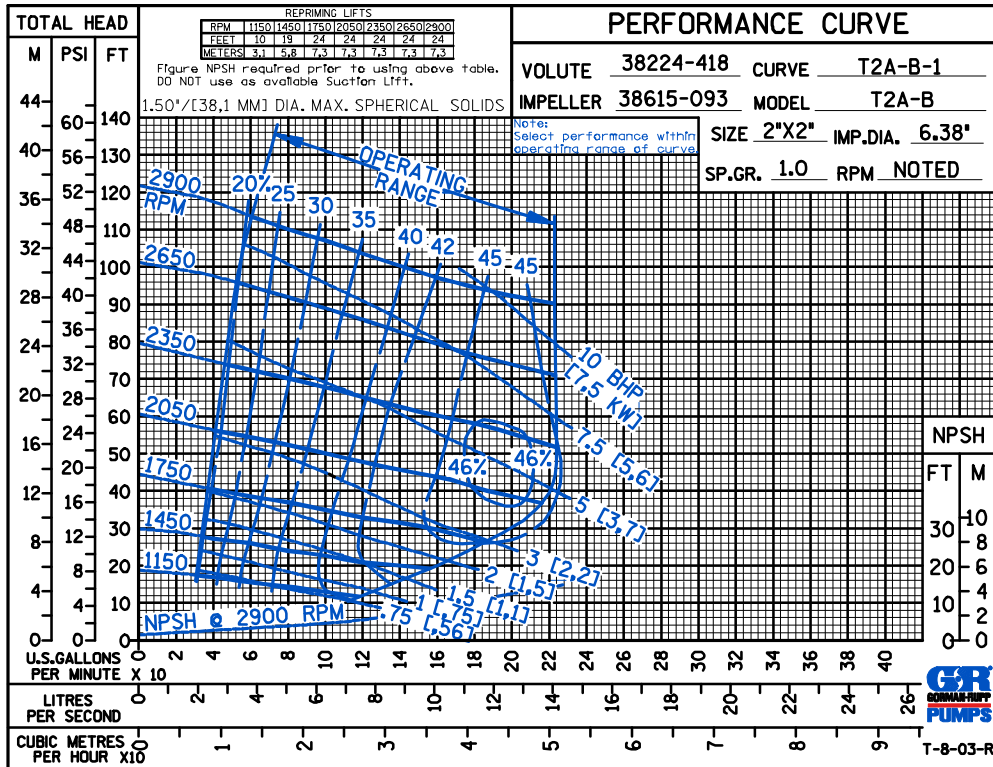

THE GORMAN-RUPP COMPANY • MANSFIELD, OHIO

GORMAN-RUPP OF CANADA LIMITED • ST. THOMAS, ONTARIO, CANADA

Specifications Subject to Change Without Notice

Printed in U.S.A.



THE GORMAN-RUPP COMPANY • MANSFIELD, OHIO

GORMAN-RUPP OF CANADA LIMITED • ST. THOMAS, ONTARIO, CANADA

www.grpumps.com

Specifications Subject to Change Without Notice

Printed in U.S.A.

© Copyright by the Gorman-Rupp Company 2007

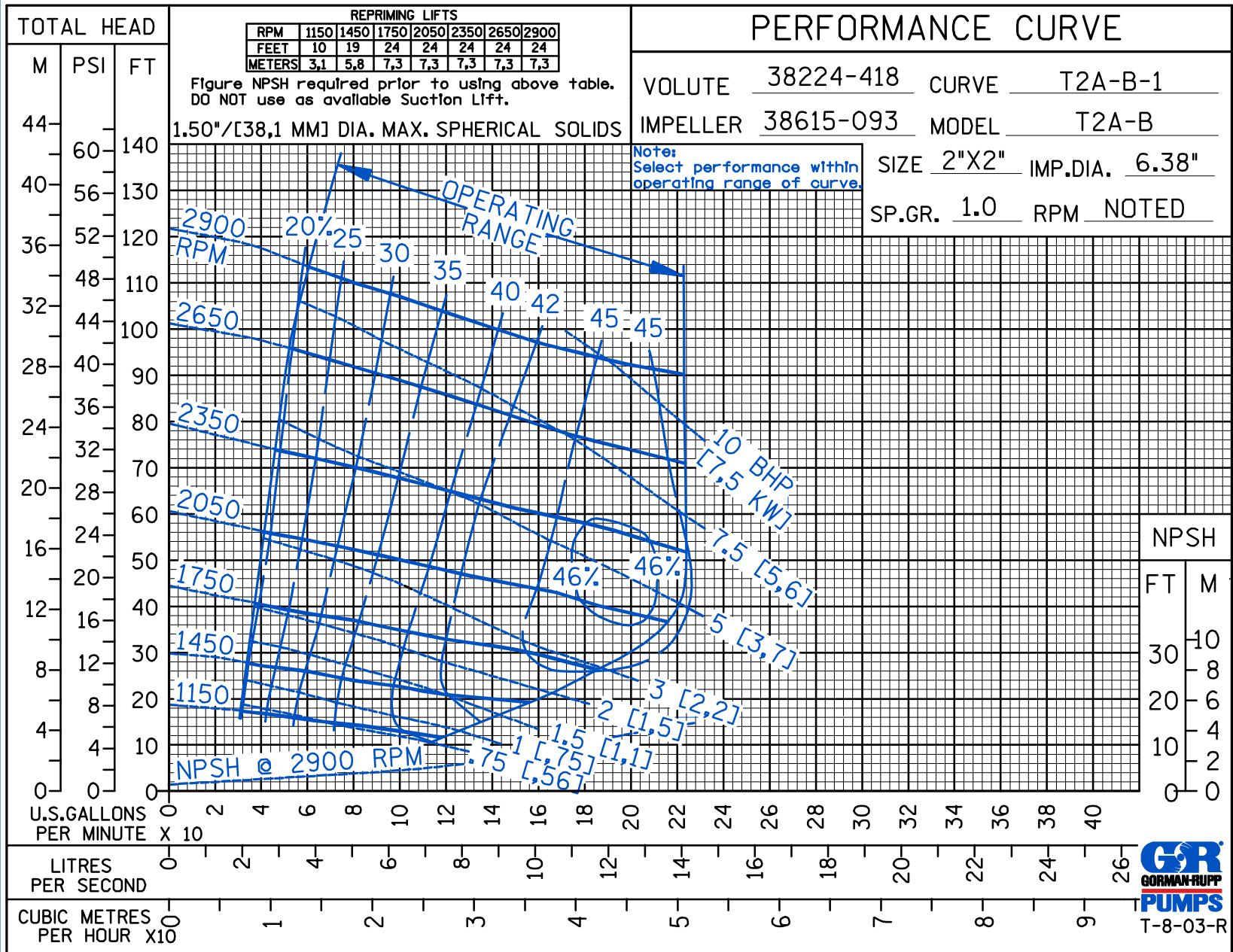

Curve Data
CDSW

Sec. 55
FEBRUARY 2007
PAGE 988.1



T-8-03-R



THE GORMAN-RUPP COMPANY • MANSFIELD, OHIO
 GORMAN-RUPP OF CANADA LIMITED • ST. THOMAS, ONTARIO, CANADA
 www.grpumps.com

© Copyright by the Gorman-Rupp Company 2007

Specifications Subject to Change Without Notice

Printed in U.S.A.

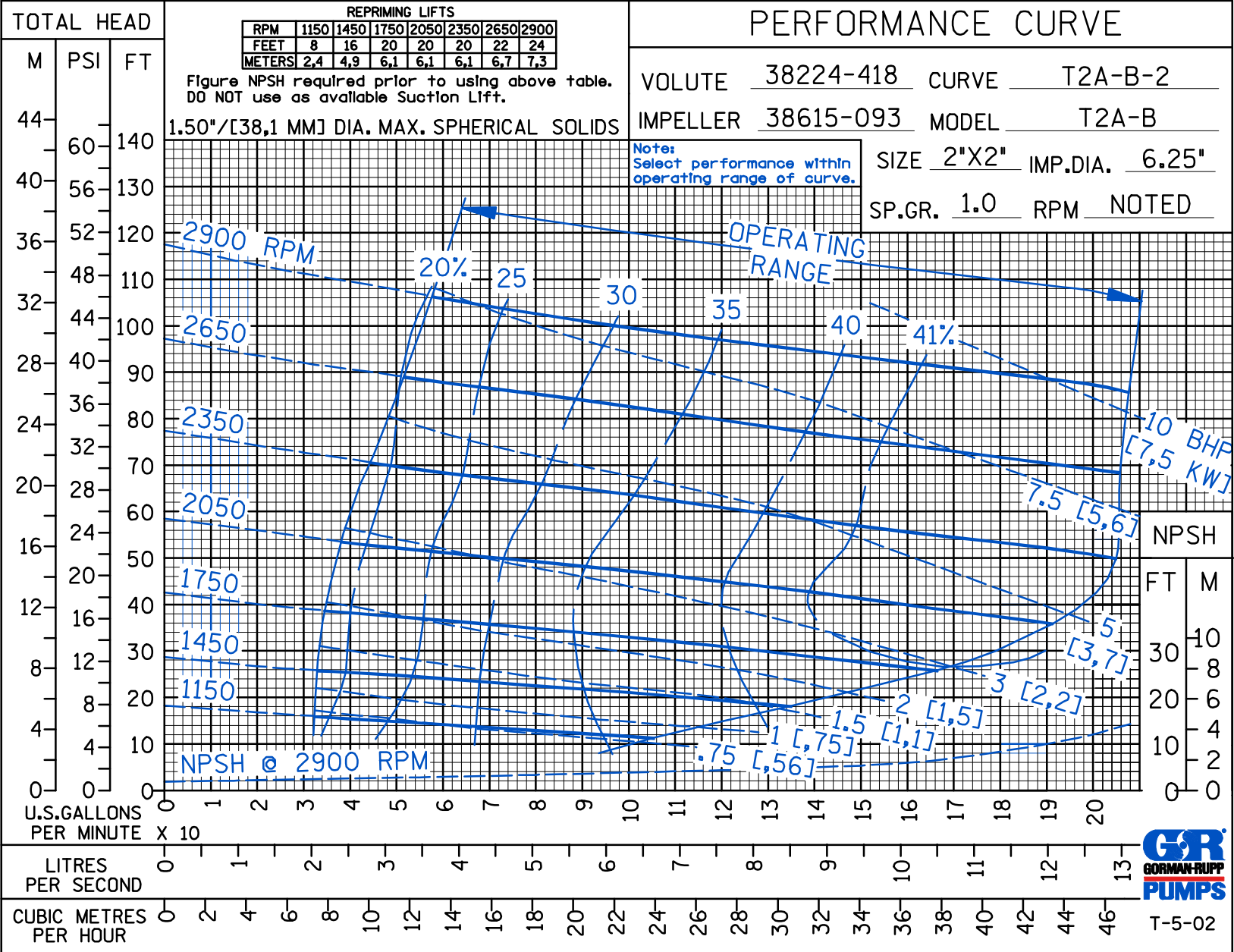



THE GORMAN-RUPP COMPANY • MANSFIELD, OHIO

GORMAN-RUPP OF CANADA LIMITED • ST. THOMAS, ONTARIO, CANADA

www.grpumps.com

Specifications: Subject to Change Without Notice

Printed in U.S.A.

© Copyright by the Gorman-Rupp Company 2007

TOTAL HEAD

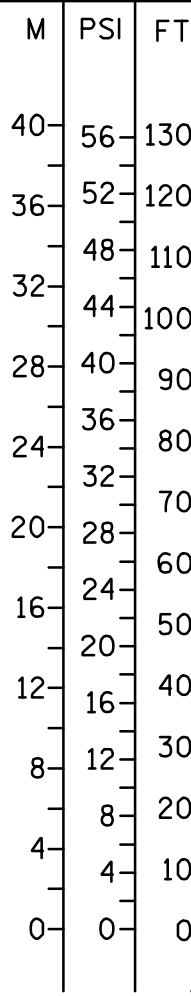

REPRIMING LIFTS

RPM	1150	1450	1750	2050	2350	2650	2900
FEET	6	11	16	18	20	24	28
METERS	1,8	3,4	4,9	5,5	6,1	7,3	8,5

Figure NPSH required prior to using above table. DO NOT use as available Suction Lift.

1.50" / [38,1 MM] DIA. MAX. SPHERICAL SOLIDS

PERFORMANCE CURVE

VOLUTE 38224-418 CURVE T2A-B-3
 IMPELLER 38615-093 MODEL T2A-B
 SIZE 2"X2" IMP.DIA. 6.00"
 SP.GR. 1.0 RPM NOTED

Note: Select performance within operating range of curve.

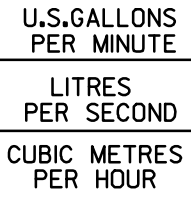
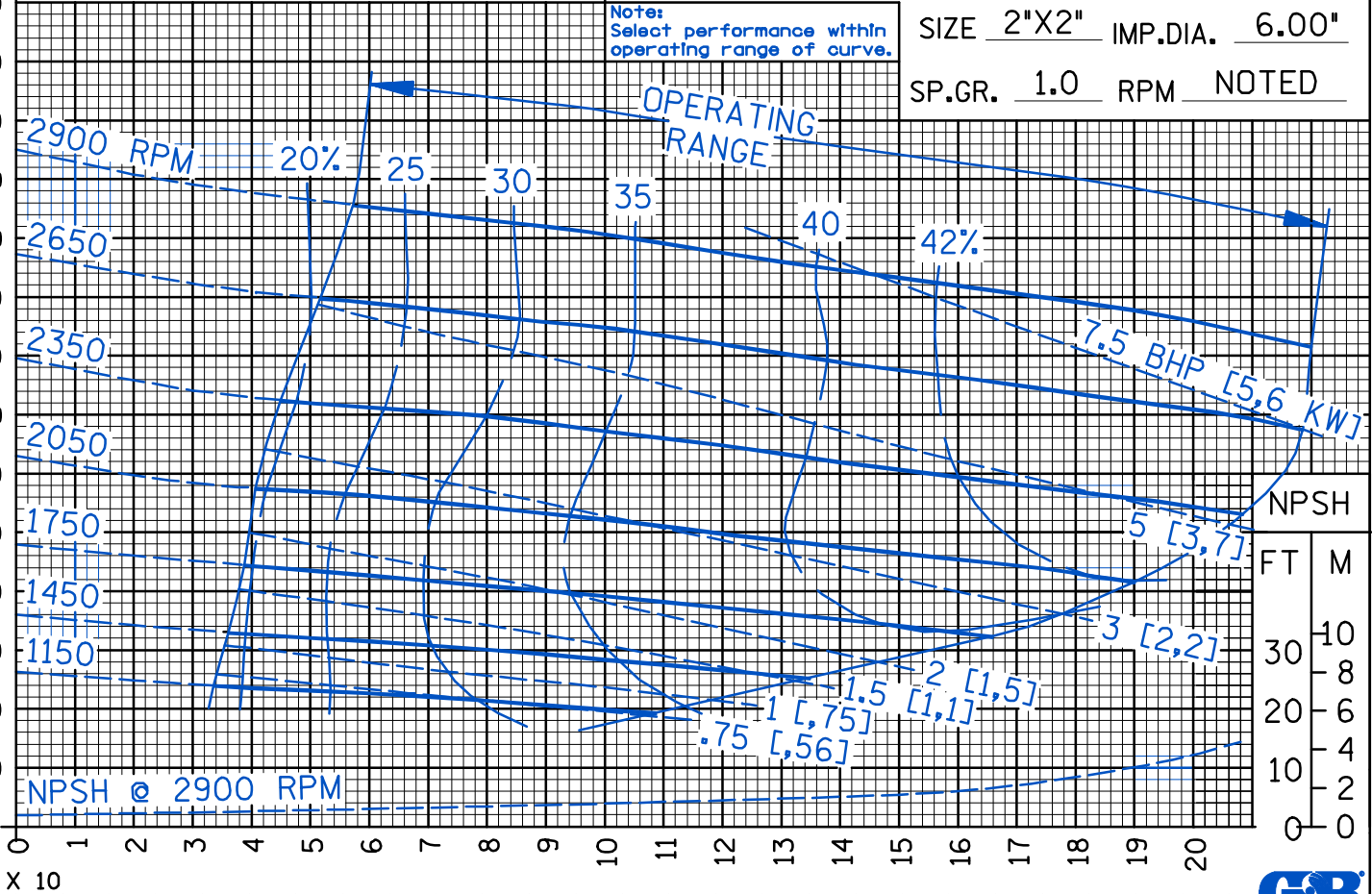

T-5-02

CDSW

Curve Data

Sec. 55

PAGE 988.3
FEBRUARY 2007



THE GORMAN-RUPP COMPANY • MANSFIELD, OHIO
 GORMAN-RUPP OF CANADA LIMITED • ST. THOMAS, ONTARIO, CANADA
 www.grpumps.com

© Copyright by the Gorman-Rupp Company 2007

Specifications Subject to Change Without Notice

Printed in U.S.A.

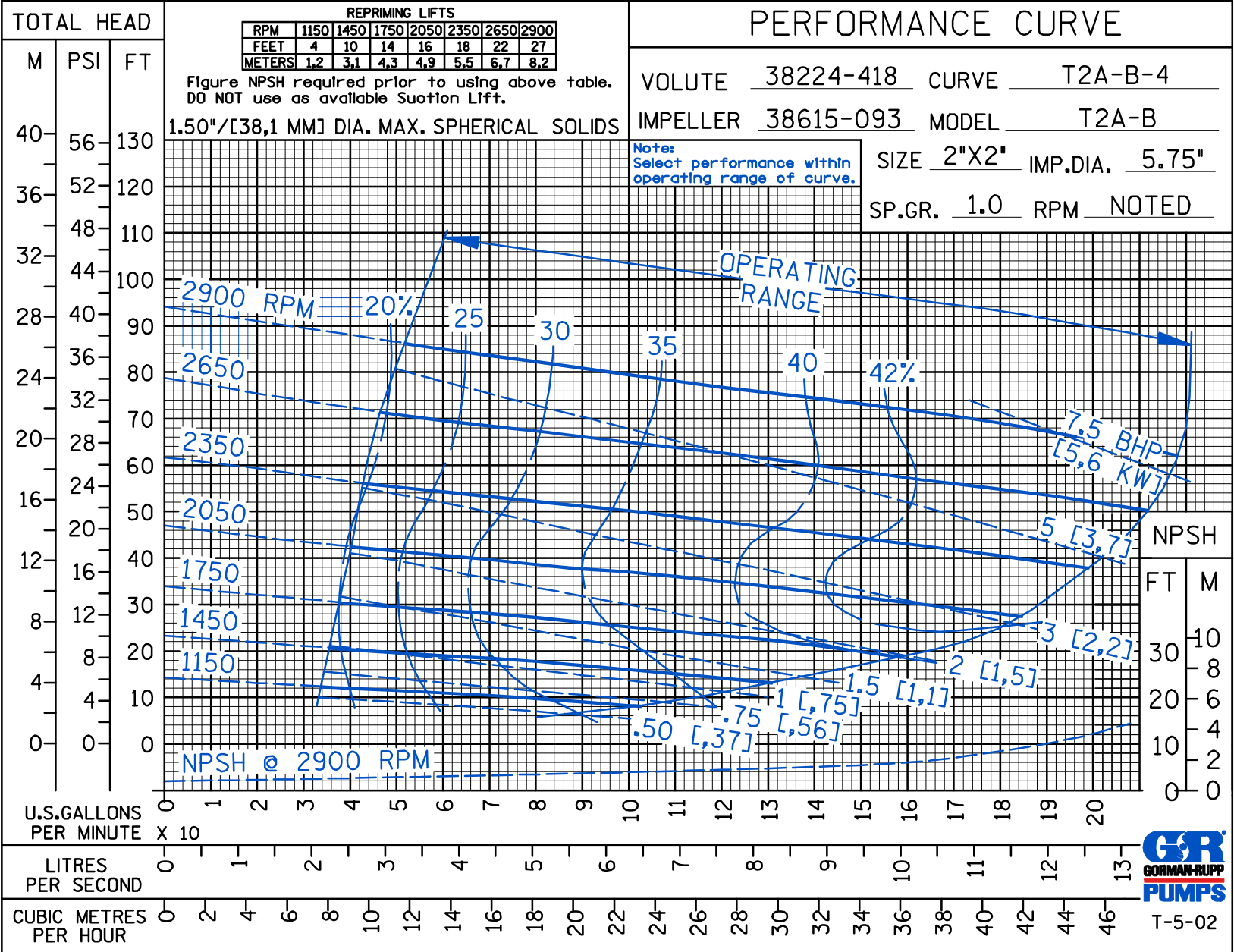

CDSW

Curve Data

Sec. 55

PAGE 988.4
FEBRUARY 2007

CDSW

PERFORMANCE CURVE

VOLUTE 38224-418 CURVE T2A-B-5
 IMPELLER 38615-093 MODEL T2A-B
 SIZE 2"X2" IMP.DIA. 5.50"
 SP.GR. 1.0 RPM NOTED

REPRIMING LIFTS							
RPM	1150	1450	1750	2050	2350	2650	2900
FEET	4	8	12	12	15	20	26
METERS	1,2	2,4	3,7	3,7	4,6	6,1	7,9

Figure NPSH required prior to using above table.
 DO NOT use as available Suction Lift.

1.50"/[38,1 MM] DIA. MAX. SPHERICAL SOLIDS

Note:
 Select performance within
 operating range of curve.

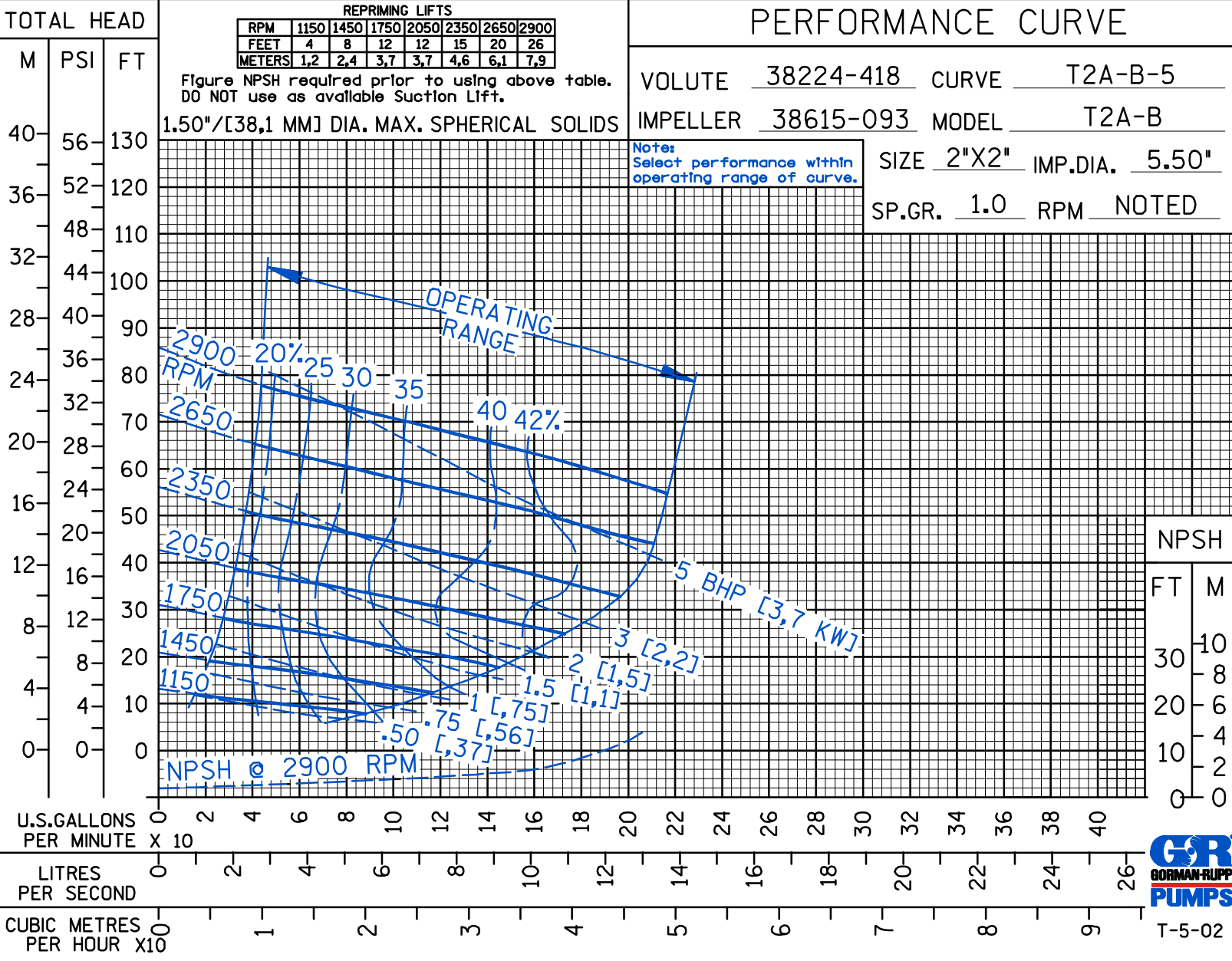

T-5-02



THE GORMAN-RUPP COMPANY • MANSFIELD, OHIO

GORMAN-RUPP OF CANADA LIMITED • ST. THOMAS, ONTARIO, CANADA

www.grpumps.com

Specifications Subject to Change Without Notice

Printed in U.S.A.

PERFORMANCE CURVE

VOLUTE 38224-418 CURVE T2A-B-6
 IMPELLER 38615-093 MODEL T2A-B
 SIZE 2"X2" IMP.DIA. NOTED
 SP.GR. 1.0 RPM 2900

REPRIMING LIFTS					
DIA.	6.38'	6.25'	6.00'	5.75'	5.50'
FEET	24	24	28	27	26
METERS	7,3	7,3	8,5	8,2	7,9

Figure NPSH required prior to using above table.
 DO NOT use as available Suction Lift.

1.50"/[38,1] DIA. MAX. SPHERICAL SOLIDS

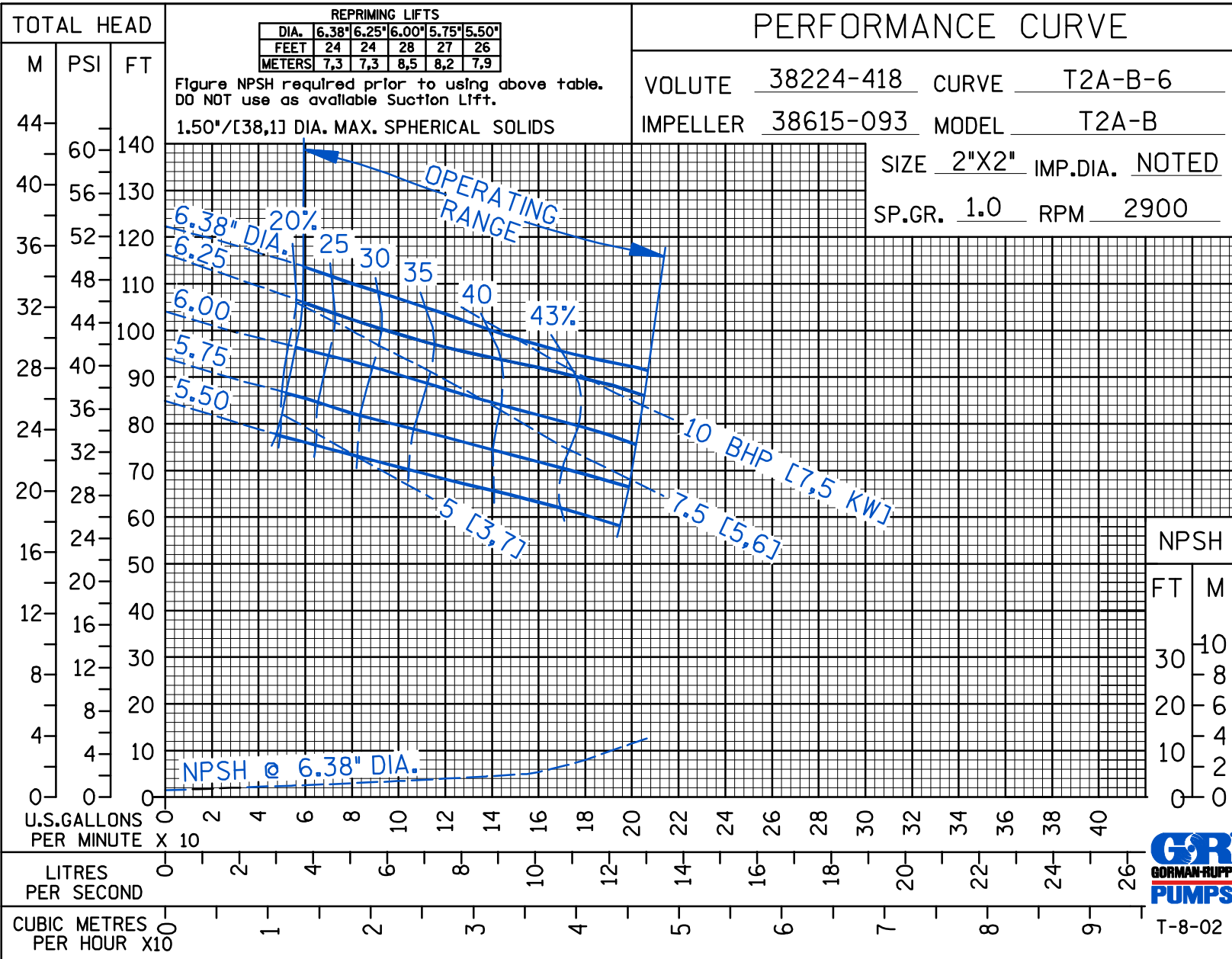

THE GORMAN-RUPP COMPANY • MANSFIELD, OHIO
 GORMAN-RUPP OF CANADA LIMITED • ST. THOMAS, ONTARIO, CANADA
 www.grpumps.com

Specifications Subject to Change Without Notice

Printed in U.S.A.

CDSW

PERFORMANCE CURVE

VOLUTE 38224-418 CURVE T2A-B-7
 IMPELLER 38615-093 MODEL T2A-B
 SIZE 2"x2" IMP.DIA. NOTED
 SP.GR. 1.0 RPM 1450

REPRIMING LIFTS					
DIA.	6.38"	6.25"	6.00"	5.75"	5.50"
FEET	19	16	11	10	8
METERS	5,8	4,9	3,4	3,1	2,4

Figure NPSH required prior to using above table.
 DO NOT use as available Suction Lift.

1.50"/[38,1] DIA. MAX. SPHERICAL SOLIDS

TOTAL HEAD

M PSI FT

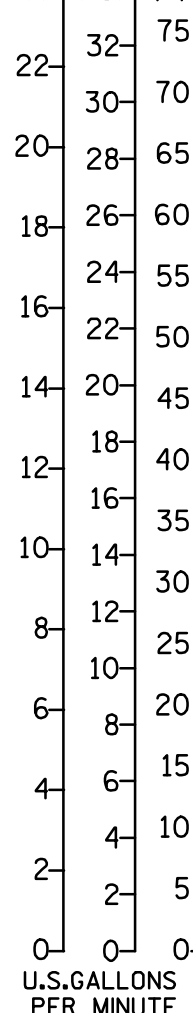

U.S. GALLONS PER MINUTE X 10
 LITRES PER SECOND
 CUBIC METRES PER HOUR

NPSH
 FT M
 30 10
 20 8
 10 6
 0 4
 0 2
 0 0



T-8-02



THE GORMAN-RUPP COMPANY • MANSFIELD, OHIO

GORMAN-RUPP OF CANADA LIMITED • ST. THOMAS, ONTARIO, CANADA

www.grpumps.com

Specifications Subject to Change Without Notice

Printed in U.S.A.

PERFORMANCE CURVE

VOLUTE 38224-418 CURVE T2A-B-8
 IMPELLER 38615-093 MODEL T2A-B
 SIZE 2"X2" IMP.DIA. NOTED
 SP.GR. 1.0 RPM 1750

REPRIMING LIFTS					
DIA.	6.38"	6.25"	6.00"	5.75"	5.50"
FEET	24	20	16	14	12
METERS	7,3	6,1	4,9	4,3	3,7

Figure NPSH required prior to using above table.
 DO NOT use as available Suction Lift.
 1.50"/[38,1 MM] DIA. MAX. SPHERICAL SOLIDS

Note:
 Select performance within
 operating range of curve.

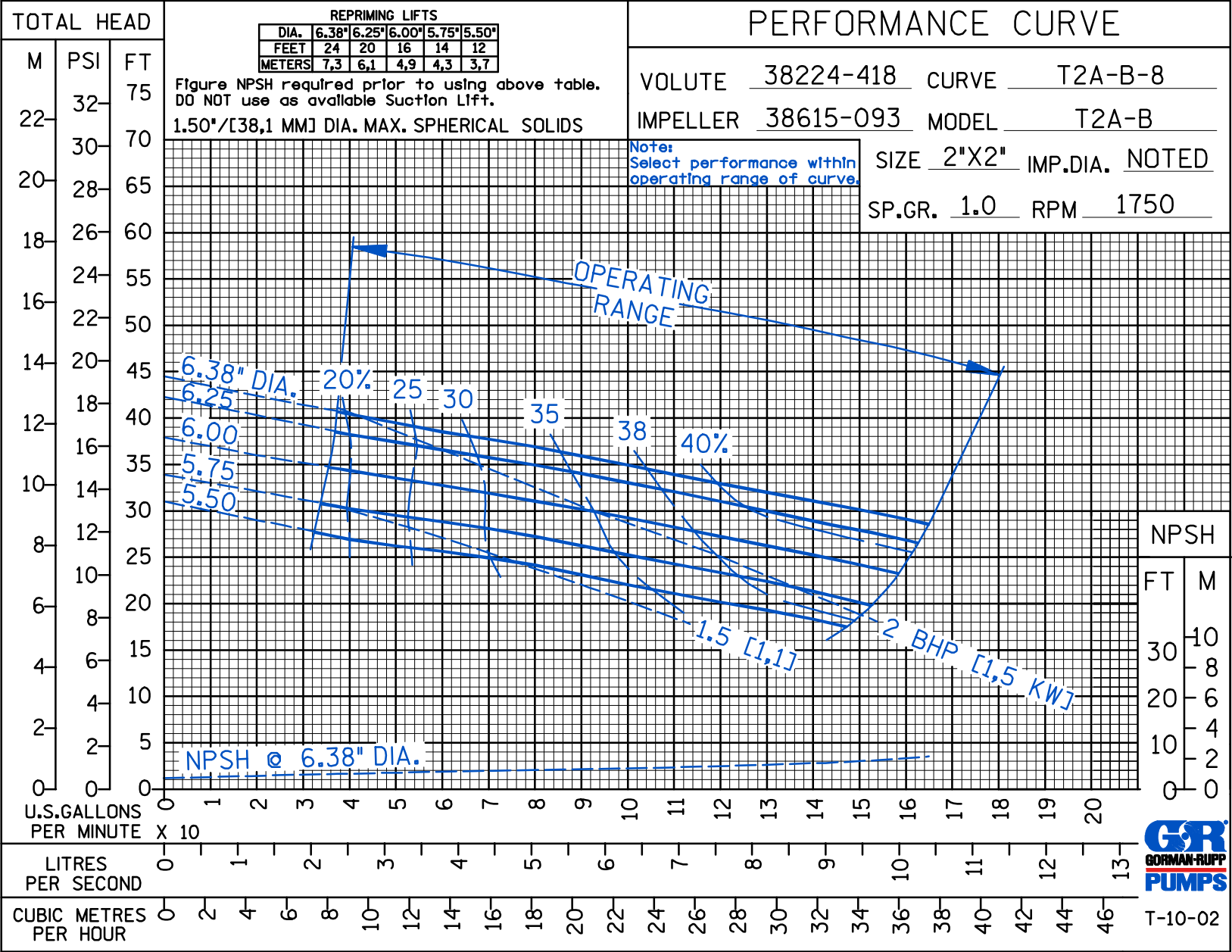

NPSH
 FT M
 30 10
 20 8
 10 4
 0 0



T-10-02



THE GORMAN-RUPP COMPANY • MANSFIELD, OHIO
 GORMAN-RUPP OF CANADA LIMITED • ST. THOMAS, ONTARIO, CANADA

www.grpumps.com
 Specifications Subject to Change Without Notice

Printed in U.S.A.

PERFORMANCE CURVE

VOLUTE 38224-418 CURVE T2A-B-9

IMPELLER 38615-093 MODEL T2A-B

SIZE 2"X2" IMP.DIA. NOTED

SP.GR. 1.0 RPM 1150

REPRIMING LIFTS					
DIA.	6.38"	6.25"	6.00"	5.75"	5.50"
FEET	10	8	6	4	4
METERS	3,1	2,4	1,8	1,2	1,2

Figure NPSH required prior to using above table.
DO NOT use as available Suction Lift.
1.50"/[38,1 MM] DIA. MAX. SPHERICAL SOLIDS

Note:
Select performance within
operating range of curve.

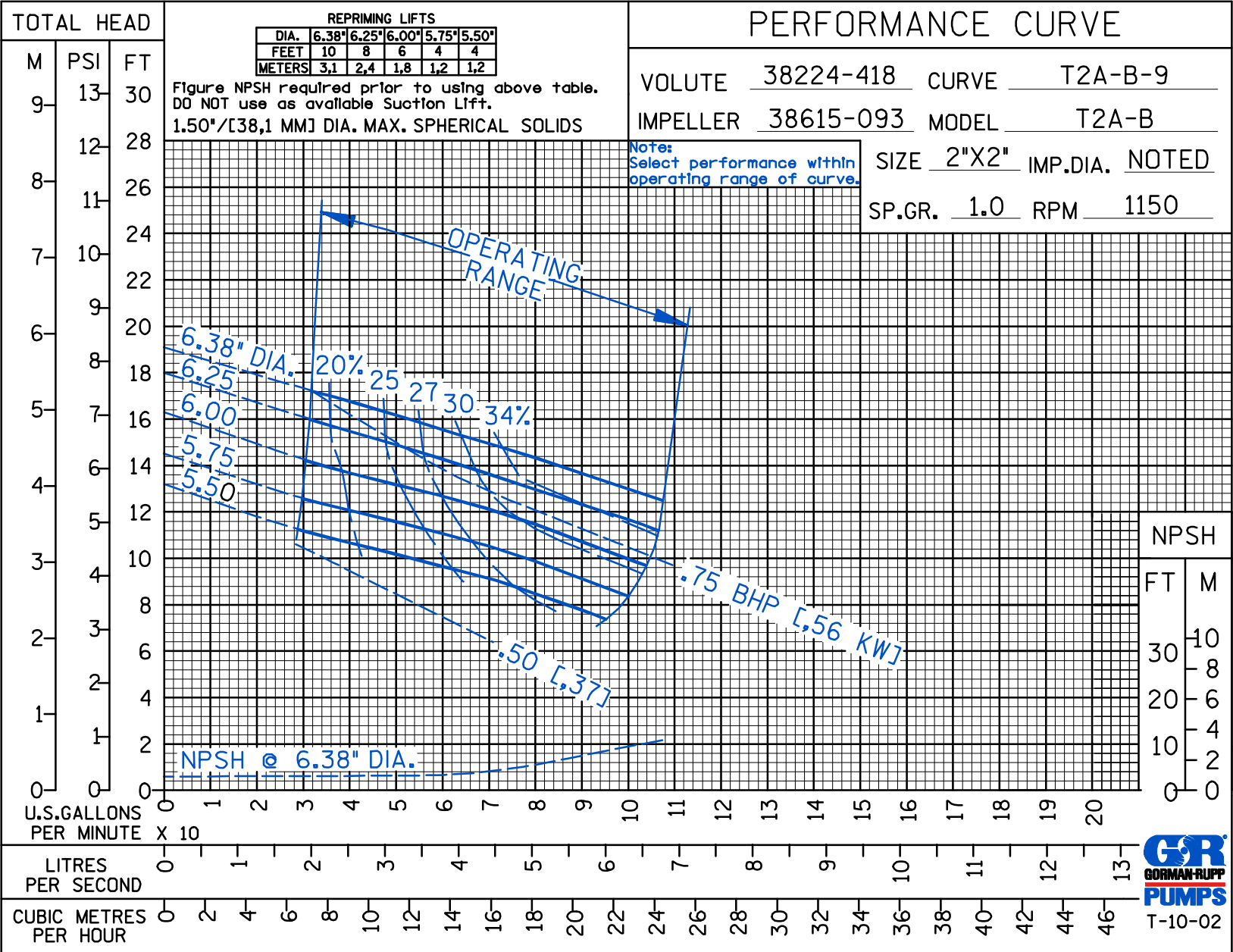

T-10-02



THE GORMAN-RUPP COMPANY • MANSFIELD, OHIO

GORMAN-RUPP OF CANADA LIMITED • ST. THOMAS, ONTARIO, CANADA

www.grpumps.com

Specifications Subject to Change Without Notice

Printed in U.S.A.

PERFORMANCE CURVE

VOLUTE 38224-418 CURVE T2A-B-11
 IMPELLER 38615-093 MODEL T2A-B
 SIZE 2"X2" IMP.DIA. 6.38"
 SP.GR. 1.0 RPM NOTED

NOTE: See single pump curve for horsepower, efficiency, & NPSH

2 PUMPS IN PARALLEL

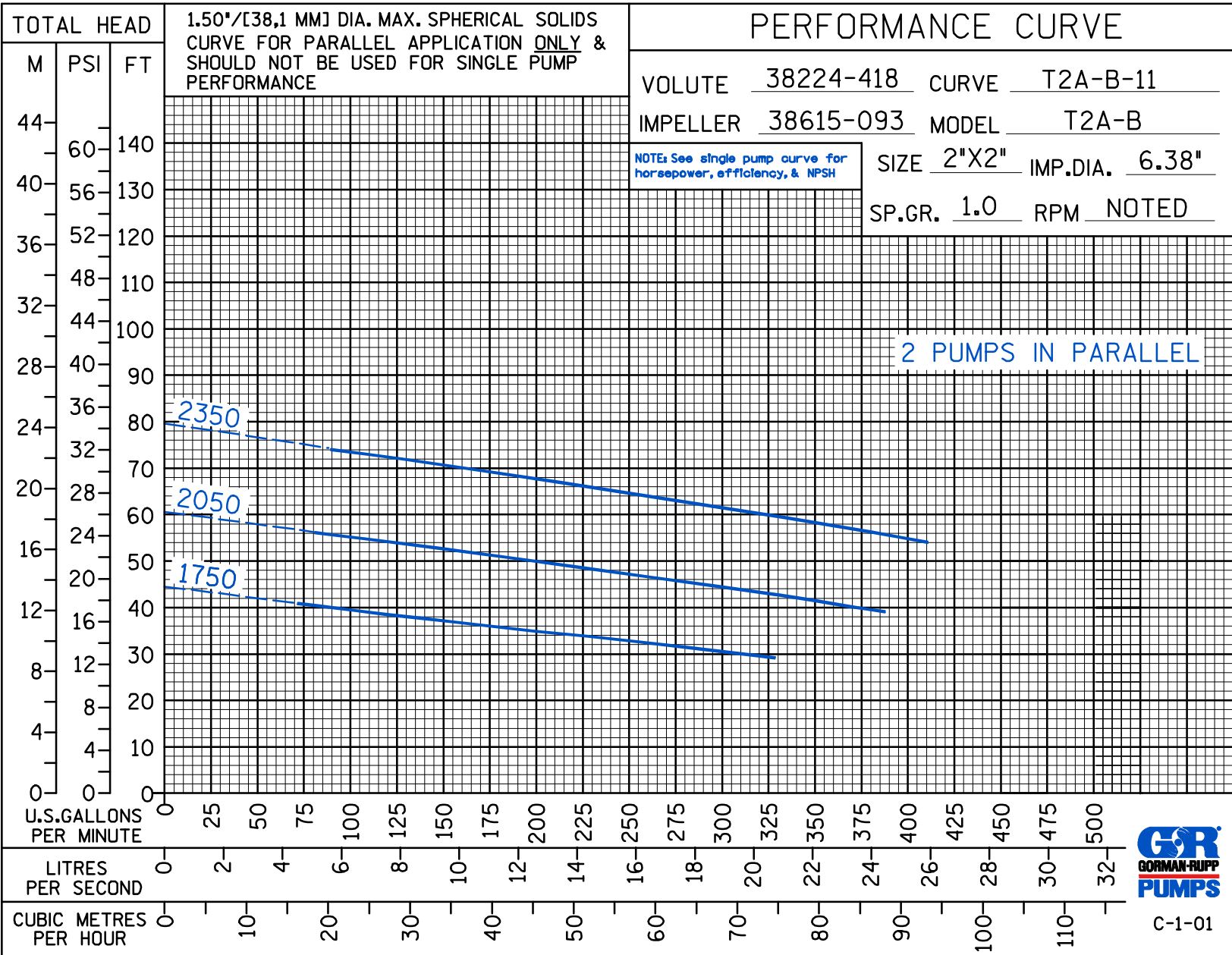

C-1-01



THE GORMAN-RUPP COMPANY • MANSFIELD, OHIO
 GORMAN-RUPP OF CANADA LIMITED • ST. THOMAS, ONTARIO, CANADA

www.grpumps.com
 Specifications Subject to Change Without Notice

Printed in U.S.A.

CDSW

PERFORMANCE CURVE

VOLUTE 38224-418 CURVE T2A-B-12

IMPELLER 38615-093 MODEL T2A-B

SIZE 2"X2" IMP.DIA. 6.38"

SP.GR. 1.0 RPM NOTED

Performance shown does not include any interconnecting piping

NOTE: Series operation is limited by the operating pressure & NPSH requirement of a single pump. See single pump curve for NPSH, EFF., & HP.

2 PUMPS IN SERIES

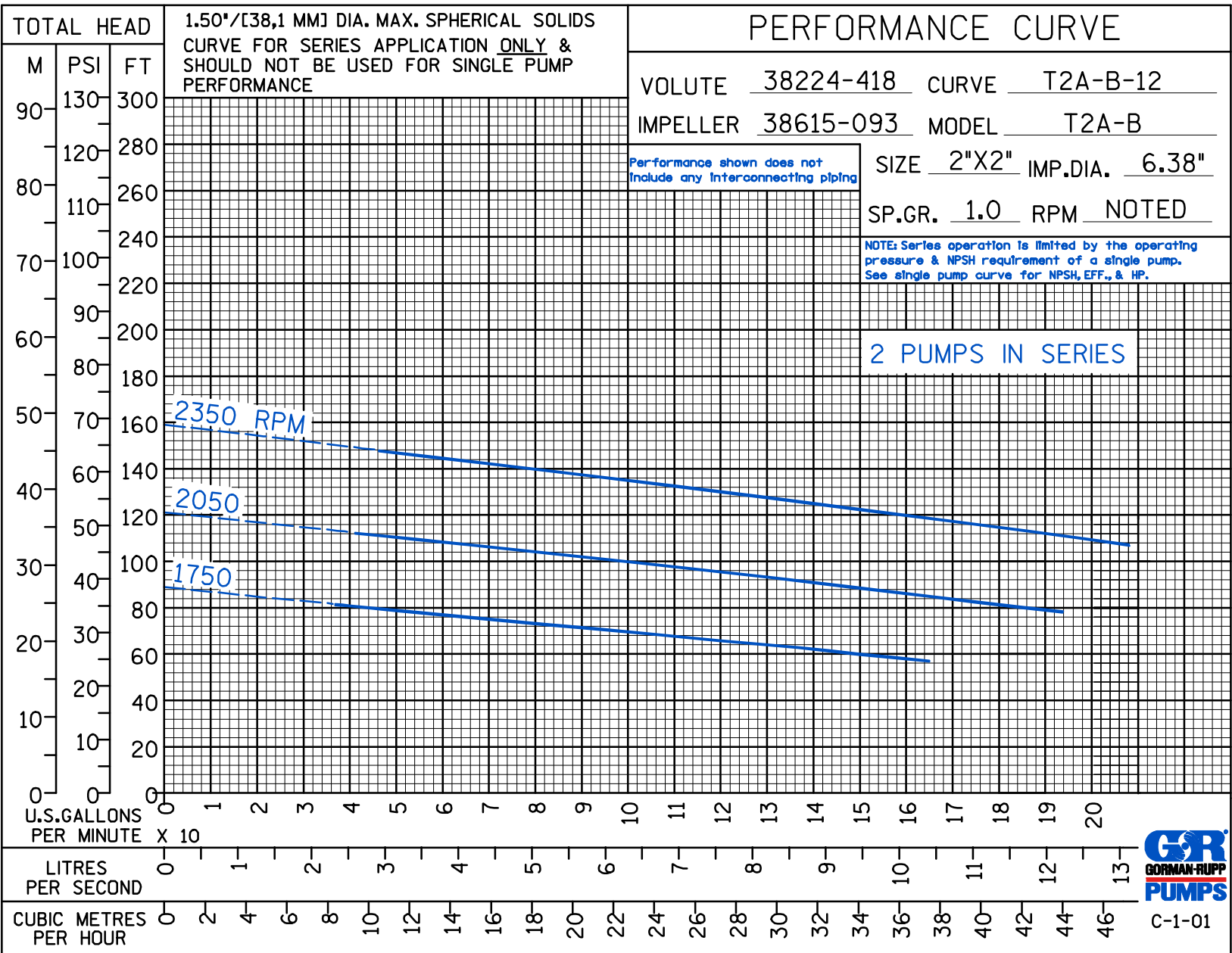

1.50"/[38,1 MM] DIA. MAX. SPHERICAL SOLIDS CURVE FOR SERIES APPLICATION ONLY & SHOULD NOT BE USED FOR SINGLE PUMP PERFORMANCE



THE GORMAN-RUPP COMPANY • MANSFIELD, OHIO

GORMAN-RUPP OF CANADA LIMITED • ST. THOMAS, ONTARIO, CANADA

www.grpumps.com

Specifications Subject to Change Without Notice

Printed in U.S.A.



C-1-01