

Stainless Steel Fitted Basic Pump

C D S W

Self Priming Centrifugal Pump



VARIOUS PATENTS APPLY

Model T3A61S-B

Size 3" x 3"



PUMP SPECIFICATIONS

- Size:** 3" x 3" (76 mm x 76 mm) NPT - Female.
- Casing:** Gray Iron No. 30.
Maximum Operating Pressure 86 psi (593 kPa).*
- Semi-Open Type, Two Vane Impeller:** Stainless Steel No. 316.
Handles 2 1/2" (63,5 mm) Diameter Spherical Solids.
- Impeller Shaft:** Stainless Steel 17-4 PH.
- Replaceable Wear Plate:** Stainless Steel No. 316.
- Removable Adjustable Cover Plate:** Gray Iron No. 30; 35 lbs. (16 kg).
- Flap Valve:** Neoprene w/Nylon and Steel Reinforcing.
- Seal Plate:** Stainless Steel No. 316.
- Bearing Housing:** Gray Iron No. 30.
- Radial and Thrust Bearings:** Open Single Row Ball.
- Bearing and Seal Cavity Lubrication:** SAE No. 30 Non-Detergent Oil.
- Flanges:** 125# Gray Iron No. 30.
- Gaskets:** Buna-N w/Compressed Synthetic Fibers, Vegetable Fiber, PTFE, Cork and Rubber.
- O-Rings:** Buna-N.
- Internal Wetted Hardware:** Stainless Steel No. 316.
- External Hardware:** Standard Plated Steel.
- Pressure Relief Valve:** Stainless Steel No. 316.
- Bearing and Seal Cavity Oil Level Sight Gauges.**
- Optional Equipment:** Automatic Air Release Valve. Metal Bellows Seal. Stainless Steel CD4MCu Impeller, Seal Plate and Wear Plate. 120V/240V Casing Heater. High Pump Temperature Shutdown Kit. Self-Cleaning Wear Plate.
- Gray Iron No. 30 Suction and Discharge Spool Flanges:
3" ASA (**Specify Model T3A61S-B /F**).
- 80 mm DIN 2527 (PN 16) (**Specify Model T3A61S-B /FM**).

**Consult Factory for Applications Exceeding Maximum Pressure and/or Temperature Indicated.*



Shown with Optional Suction & Discharge Spool Flanges (Available in ASA or DIN Standard Sizes).

SEAL SPECIFICATIONS

Mechanical, Oil-Lubricated, Double Floating, Self-Aligning. Silicon Carbide Rotating and Stationary Faces. Stainless Steel No. 316 Stationary Seat. Fluorocarbon Elastomers (DuPont Viton® or Equivalent). Stainless Steel No. 18-8 Cage and Spring. Maximum Temperature of Liquid Pumped, 160°F (71°C).*

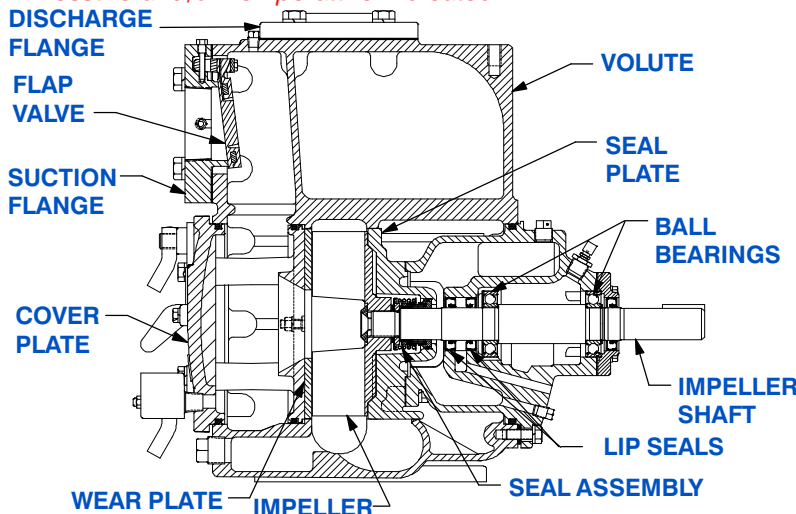

SEAL DETAIL

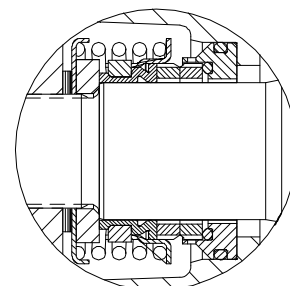

THE GORMAN-RUPP COMPANY • MANSFIELD, OHIO

GORMAN-RUPP OF CANADA LIMITED • ST. THOMAS, ONTARIO, CANADA

www.grpumps.com

Specifications Subject to Change Without Notice

Printed in U.S.A.

Specification Data

SECTION 55, PAGE 2020

APPROXIMATE DIMENSIONS and WEIGHTS

NET WEIGHT: 420 LBS. (191 KG.)*
SHIPPING WEIGHT: 468 LBS. (212 KG.)*
EXPORT CRATE: 19.3 CU. FT. (0,55 CU. M.)
***ADD 10 LBS. (4,5 KG.) W/EACH SPOOL FLANGE**

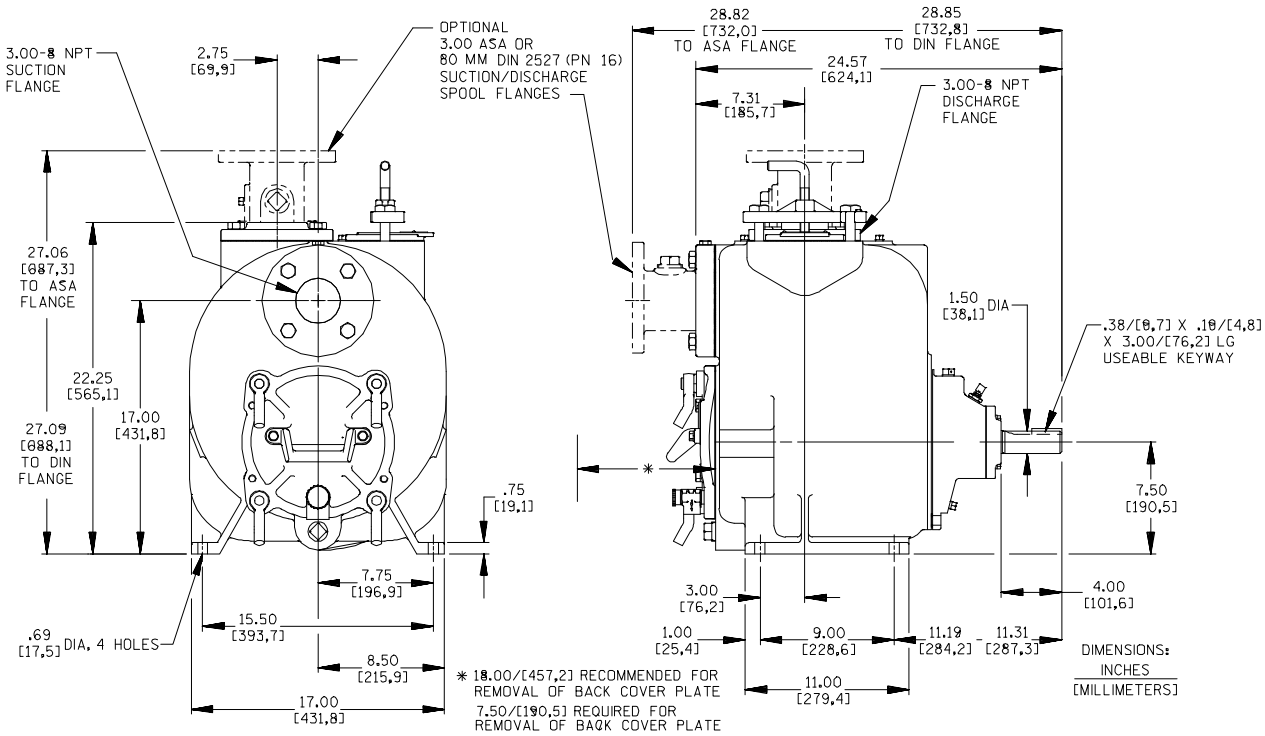

OPTIONAL ASA OR DIN STANDARD SUCTION & DISCHARGE SPOOL FLANGES AVAILABLE

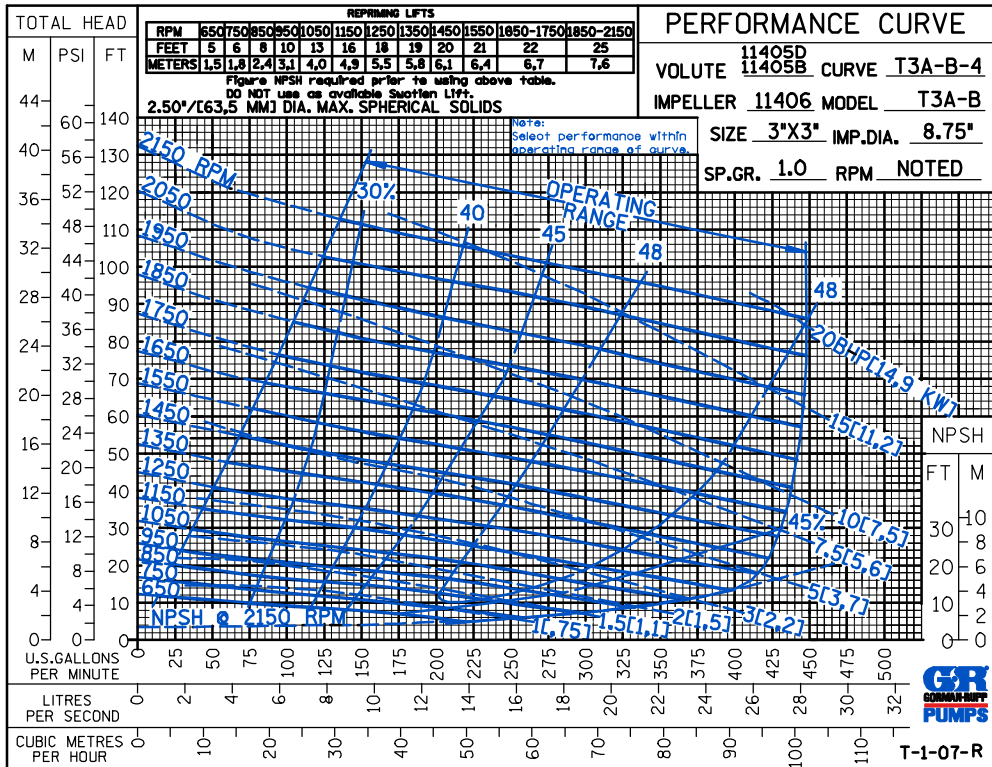

THE GORMAN-RUPP COMPANY • MANSFIELD, OHIO

GORMAN-RUPP OF CANADA LIMITED • ST. THOMAS, ONTARIO, CANADA

Specifications Subject to Change Without Notice

Printed in U.S.A.

PERFORMANCE CURVE

VOLUTE 11405D
11405B CURVE T3A-B-1
 IMPELLER 11406 MODEL T3A-B
 SIZE 3"X3" IMP.DIA. NOTED
 SP.GR. 1.0 RPM 1750

Note:
Select performance within
operating range of curve.

REPRIMING LIFTS					
DIA.	7.75"	8"	8.25"	8.50"	8.75"
FEET	12	13	16	20	22
METERS	3,7	4	4,9	6,1	6,7

Figure NPSH required prior to using above table.
DO NOT use as available Suotion Lift.
2.50"/[63,5 MM] DIA. MAX. SPHERICAL SOLIDS

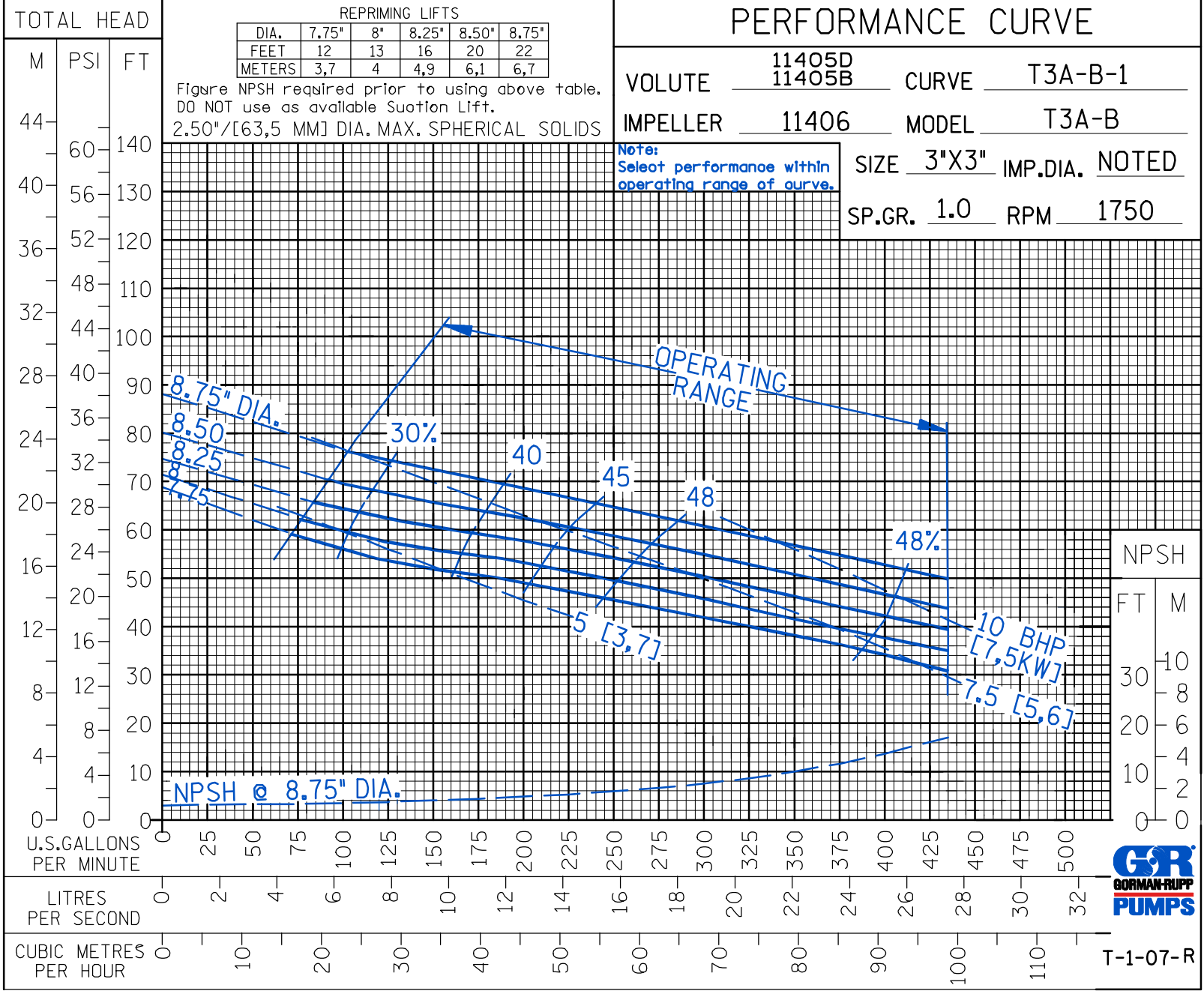

NPSH
FT M



T-1-07-R



THE GORMAN-RUPP COMPANY • MANSFIELD, OHIO

GORMAN-RUPP OF CANADA LIMITED • ST. THOMAS, ONTARIO, CANADA

www.grpumps.com

Specifications Subject to Change Without Notice

Printed in U.S.A.

PERFORMANCE CURVE

VOLUTE 11405D
11405B CURVE T3A-B-2
IMPELLER 11406 MODEL T3A-B
SIZE 3"X3" IMP.DIA. NOTED
SP.GR. 1.0 RPM 1150

Note:
Select performance within
operating range of curve.

REPRIMING LIFTS					
DIA.	7.75'	8'	8.25'	8.50'	8.75'
FEET	8	8	9	12	16
METERS	2,4	2,4	2,7	3,7	4,9

Figure NPSH required prior to using above table.
DO NOT use as available Suction Lift.
2.50"/[63,5 MM] DIA. MAX. SPHERICAL SOLIDS

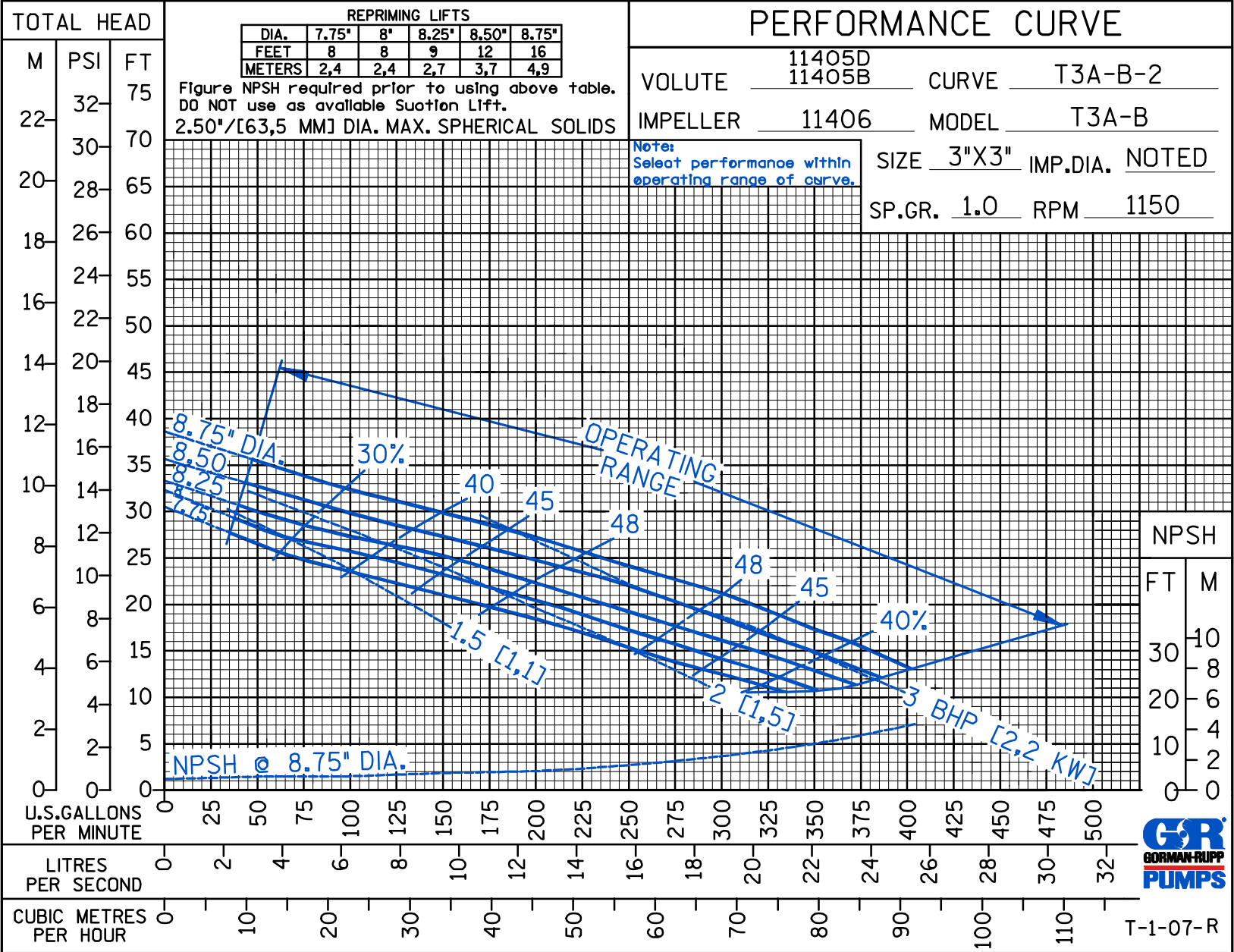

T-1-07-R



THE GORMAN-RUPP COMPANY • MANSFIELD, OHIO
GORMAN-RUPP OF CANADA LIMITED • ST. THOMAS, ONTARIO, CANADA

www.grpumps.com
Specifications Subject to Change Without Notice

Printed in U.S.A.

CDSW

PERFORMANCE CURVE

VOLUTE 11405D
11405B CURVE T3A-B-3
IMPELLER 11406 MODEL T3A-B
SIZE 3"X3" IMP.DIA. NOTED
SP.GR. 1.0 RPM 860

REPRIMING LIFTS					
DIA.	7.75'	8'	8.25'	8.50'	8.75'
FEET	4	5	6	7	8
METERS	1,2	1,5	1,8	2,1	2,4

Figure NPSH required prior to using above table.
DO NOT use as available Suction Lift.
2.50"/[63,5 MM] DIA. MAX. SPHERICAL SOLIDS

Note:
Select performance within
operating range of curve.

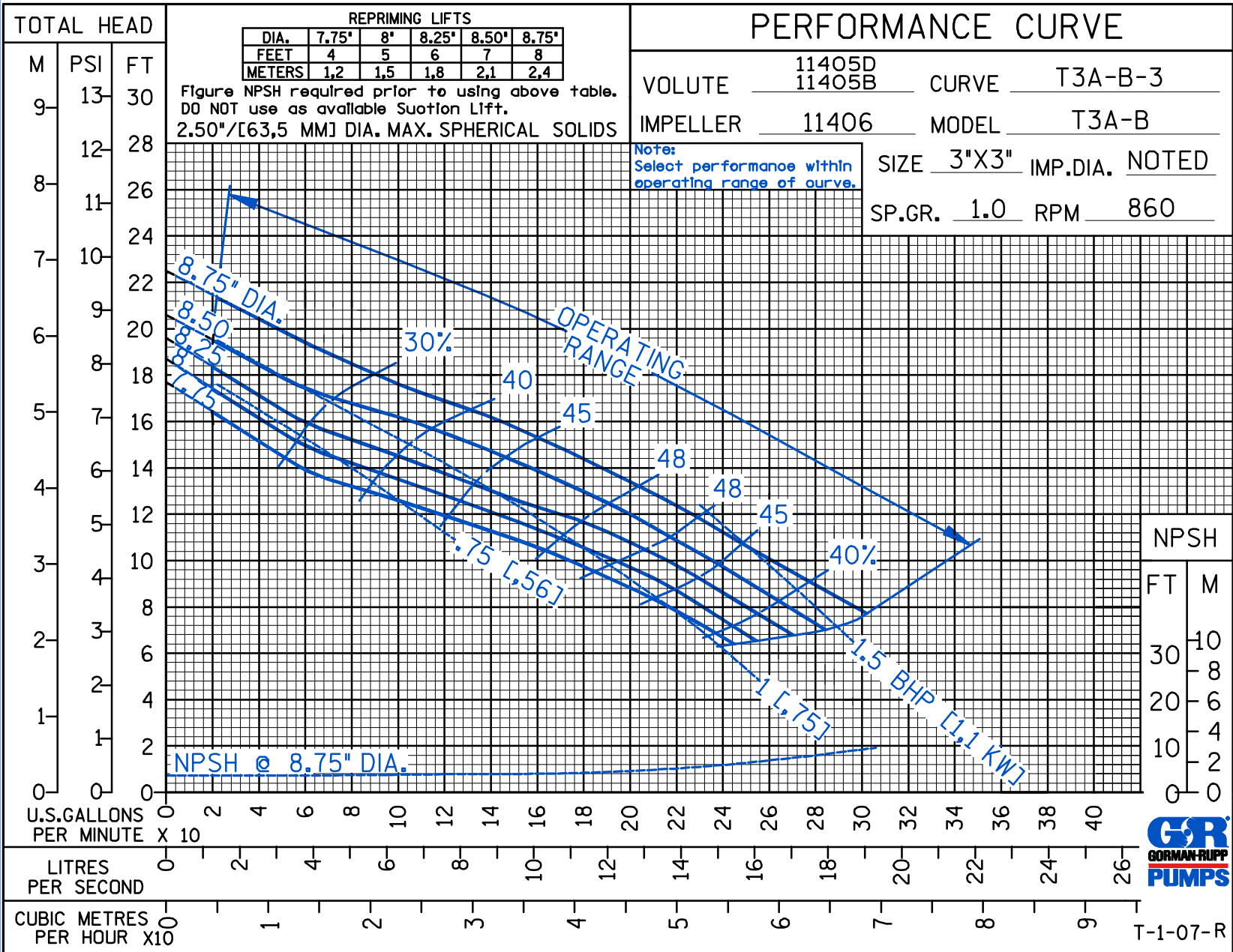

NPSH
FT M



T-1-07-R



THE GORMAN-RUPP COMPANY • MANSFIELD, OHIO

GORMAN-RUPP OF CANADA LIMITED • ST. THOMAS, ONTARIO, CANADA

www.grpumps.com

Specifications Subject to Change Without Notice

Printed in U.S.A.

PERFORMANCE CURVE

VOLUTE 11405D
11405B CURVE T3A-B-4
IMPELLER 11406 MODEL T3A-B
SIZE 3"X3" IMP.DIA. 8.75"
SP.GR. 1.0 RPM NOTED

REPRIMING LIFTS												
RPM	650	750	850	950	1050	1150	1250	1350	1450	1550	1650-1750	1850-2150
FEET	5	6	8	10	13	16	18	19	20	21	22	25
METERS	1,5	1,8	2,4	3,1	4,0	4,9	5,5	5,8	6,1	6,4	6,7	7,6

Figure NPSH required prior to using above table.
DO NOT use as available Suction Lift.
2.50"/[63,5 MM] DIA. MAX. SPHERICAL SOLIDS

Note:
Select performance within
operating range of curve.

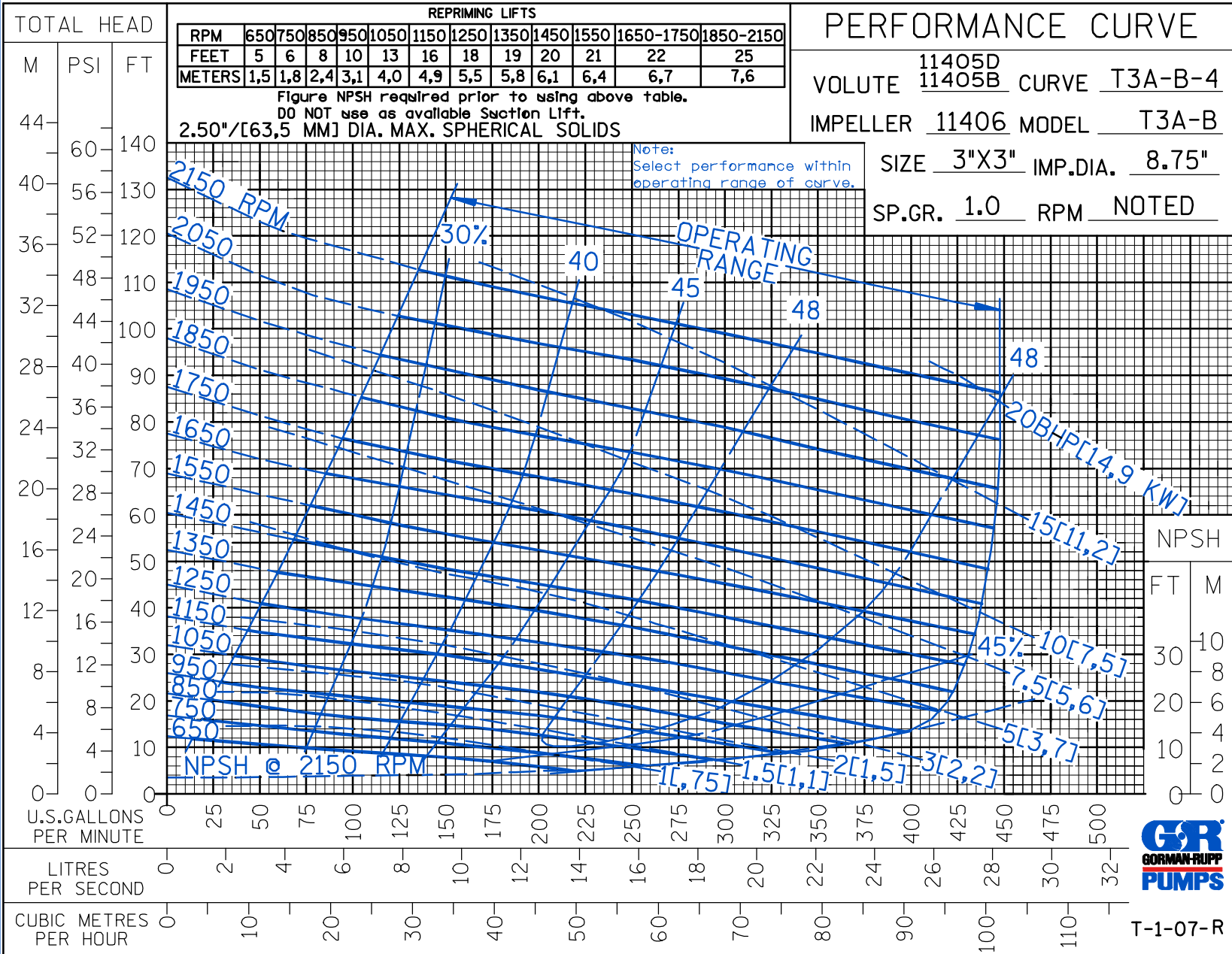

T-1-07-R



THE GORMAN-RUPP COMPANY • MANSFIELD, OHIO
GORMAN-RUPP OF CANADA LIMITED • ST. THOMAS, ONTARIO, CANADA

www.grpumps.com
Specifications Subject to Change Without Notice

Printed in U.S.A.



THE GORMAN-RUPP COMPANY • MANSFIELD, OHIO
 GORMAN-RUPP OF CANADA LIMITED • ST. THOMAS, ONTARIO, CANADA
 www.grpumps.com

© Copyright by the Gorman-Rupp Company 2007

Specifications Subject to Change Without Notice

Printed in U.S.A.

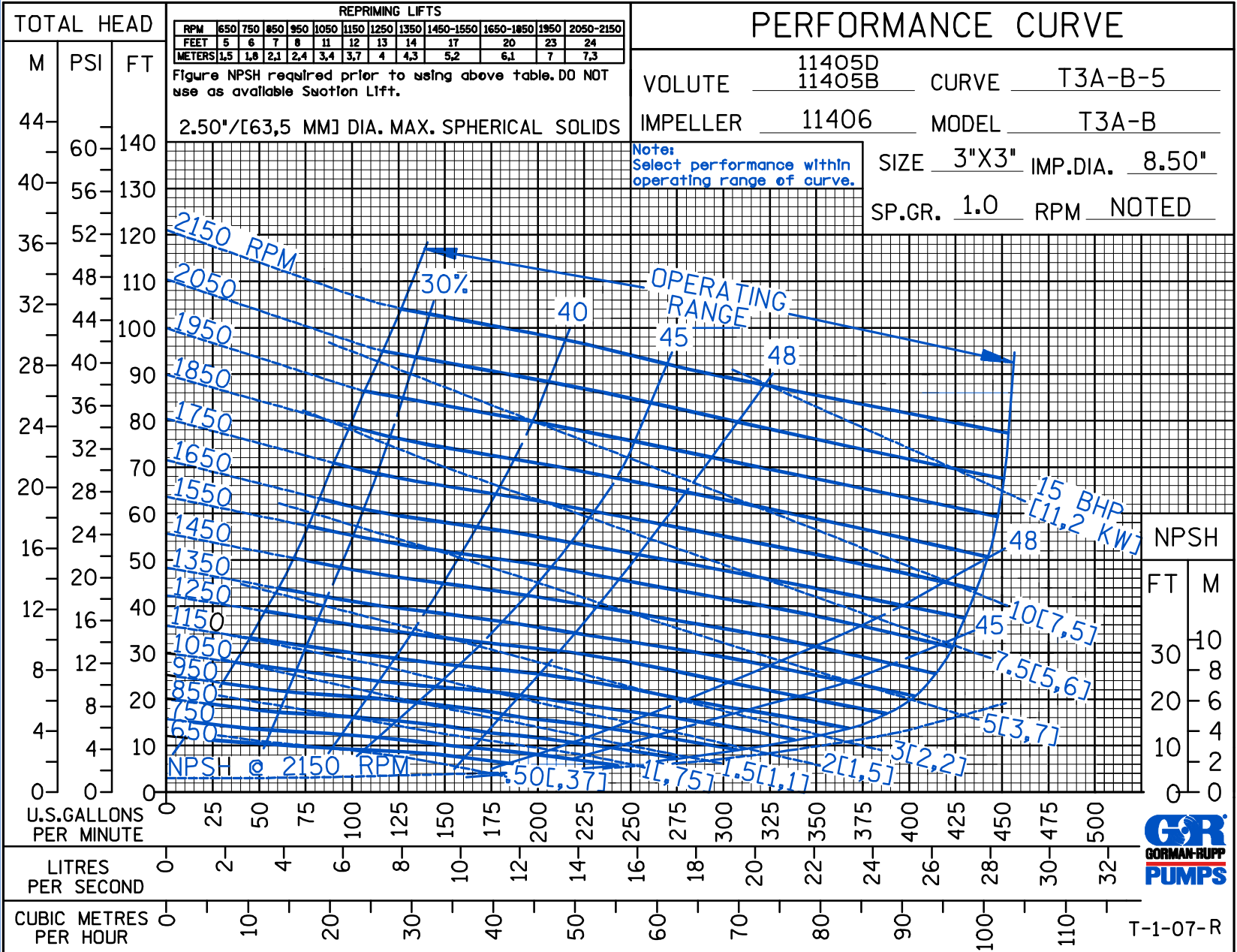

CDSW

Curve Data

Sec. 55

PAGE 2051.5
 FEBRUARY 2007



THE GORMAN-RUPP COMPANY • MANSFIELD, OHIO
 GORMAN-RUPP OF CANADA LIMITED • ST. THOMAS, ONTARIO, CANADA
 www.grpumps.com

© Copyright by the Gorman-Rupp Company 2007

Specifications Subject to Change Without Notice

Printed in U.S.A.

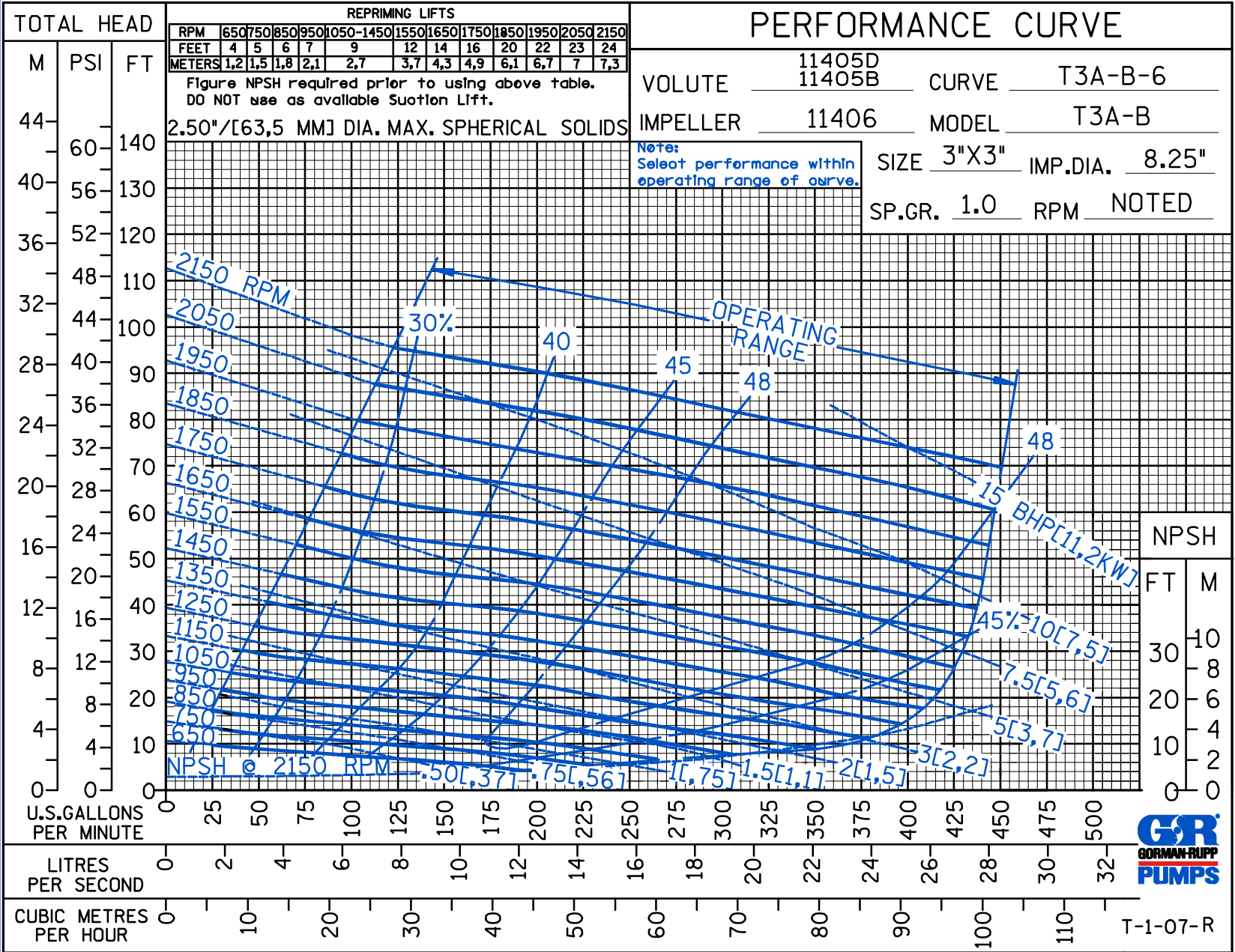

CDSW

Curve Data

Sec. 55

PAGE 2051.6
 FEBRUARY 2007



THE GORMAN-RUPP COMPANY • MANSFIELD, OHIO
 GORMAN-RUPP OF CANADA LIMITED • ST. THOMAS, ONTARIO, CANADA
 www.grpumps.com

© Copyright by the Gorman-Rupp Company 2007

Specifications Subject to Change Without Notice

Printed in U.S.A.

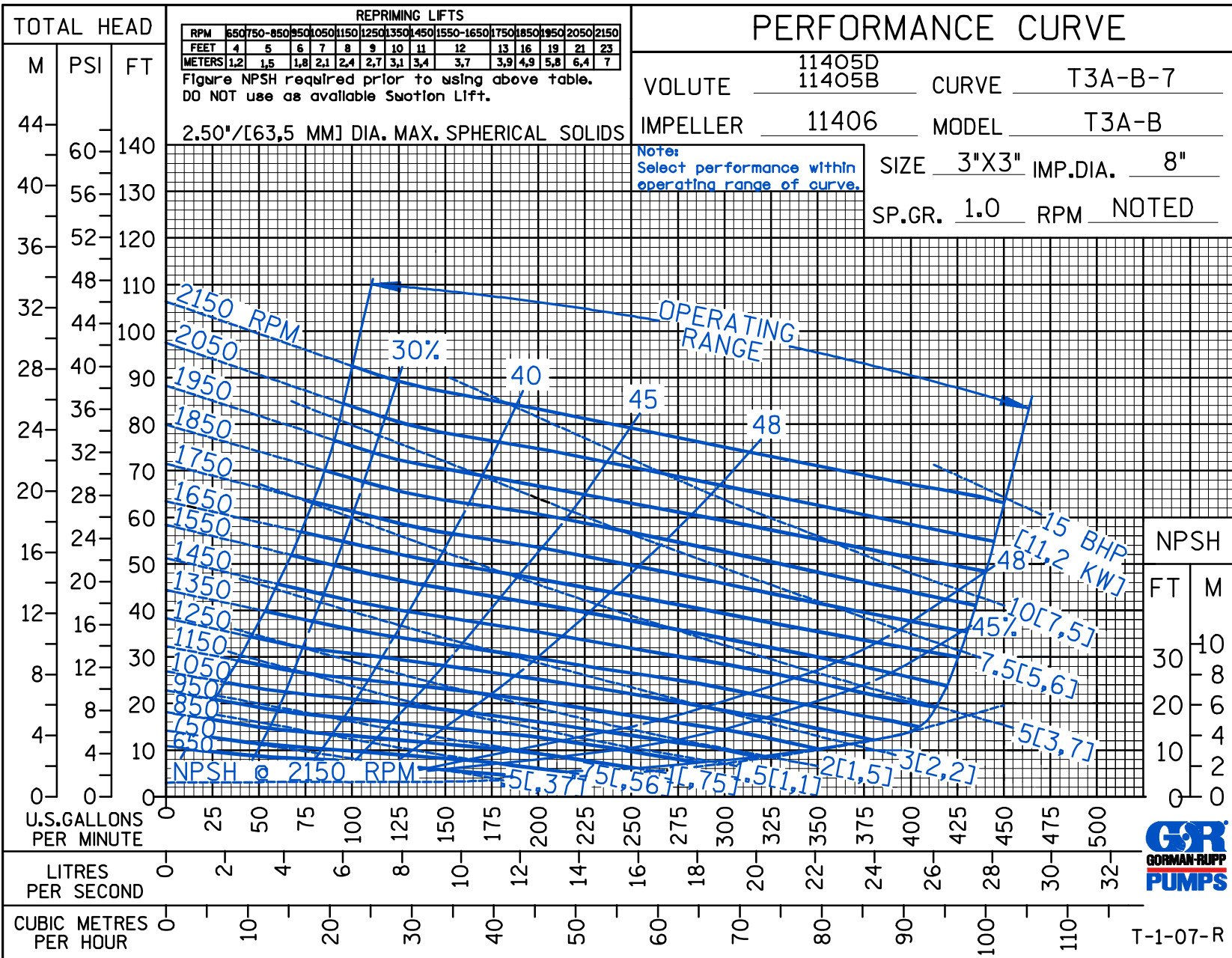

CDSW

Curve Data

Sec. 55

PAGE 2051.7
 FEBRUARY 2007



T-1-07-R



THE GORMAN-RUPP COMPANY • MANSFIELD, OHIO
 GORMAN-RUPP OF CANADA LIMITED • ST. THOMAS, ONTARIO, CANADA
 www.grpumps.com

© Copyright by the Gorman-Rupp Company 2007

Specifications Subject to Change Without Notice

Printed in U.S.A.

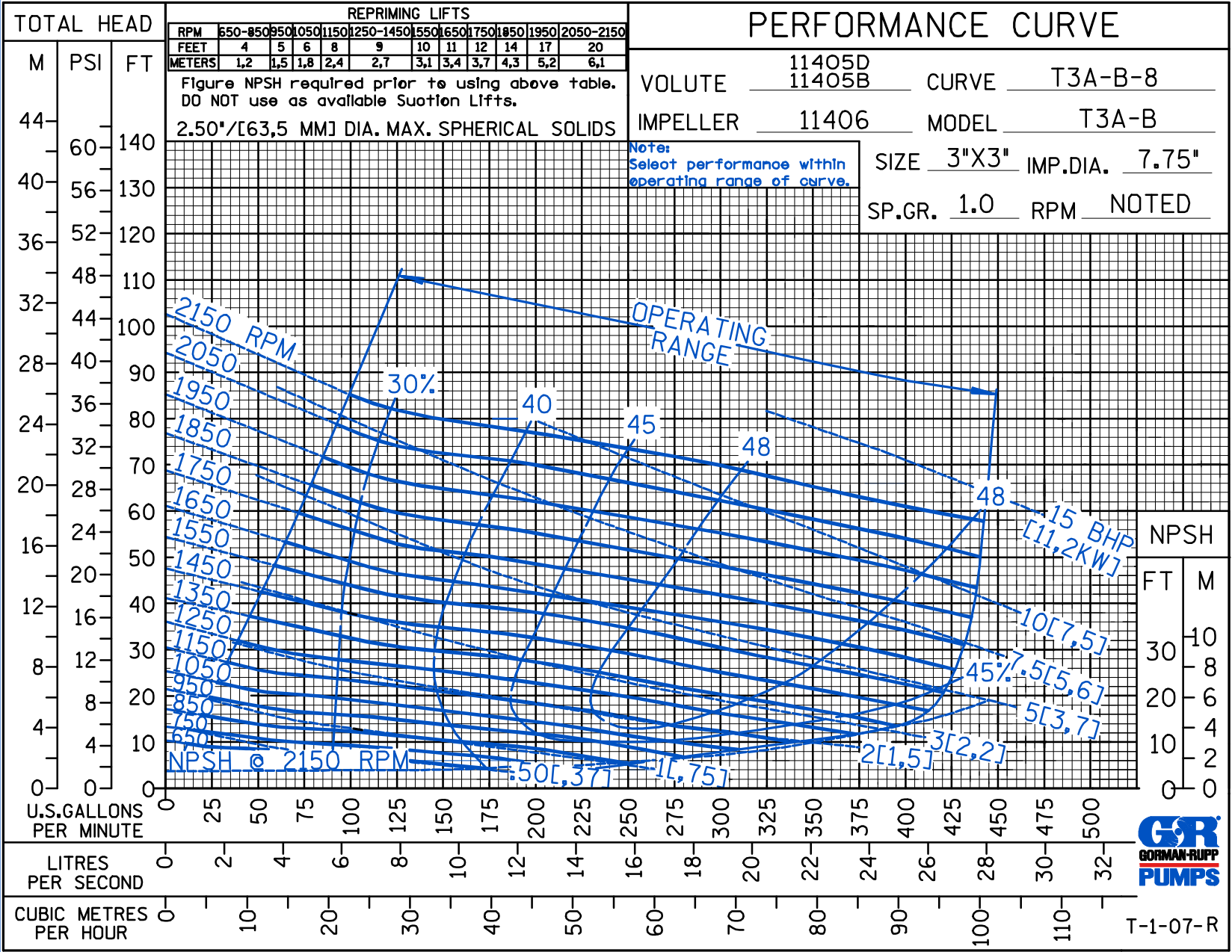

CDSW

Curve Data

Sec. 55

PAGE 2051.8
 FEBRUARY 2007



T-1-07-R

CDSW

PERFORMANCE CURVE

VOLUTE 11405D
11405B CURVE T3A-B-9
 IMPELLER 11406 MODEL T3A-B
 SIZE 3"X3" IMP.DIA. NOTED
 SP.GR. 1.0 RPM 1450

REPRIMING LIFTS					
DIA.	7.75"	8"	8.25"	8.50"	8.75"
FEET	9	11	9	17	20
METERS	2,7	3,4	2,7	5,2	6,1

Figure NPSH required prior to using above table.
 DO NOT use as available Section Lift.
 2.50"/[63,5 MM] DIA. MAX. SPHERICAL SOLIDS

Note:
 Select performance within
 operating range of curve

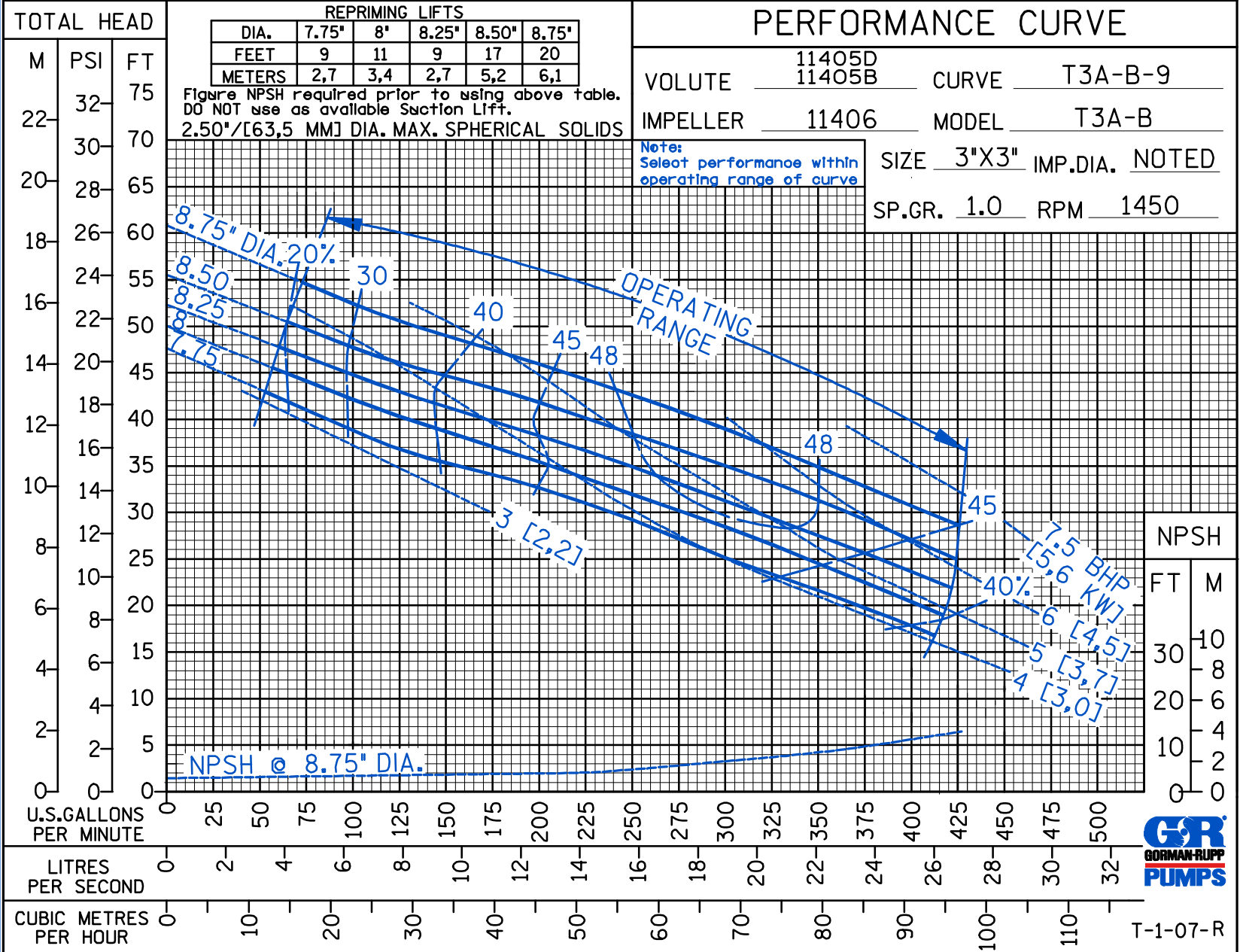

NPSH
 FT M
 30 10
 20 8
 10 6
 0 0



T-1-07-R



THE GORMAN-RUPP COMPANY • MANSFIELD, OHIO
 GORMAN-RUPP OF CANADA LIMITED • ST. THOMAS, ONTARIO, CANADA
 www.grpumps.com

Specifications Subject to Change Without Notice

© Copyright by the Gorman-Rupp Company 2007

Printed in U.S.A.



THE GORMAN-RUPP COMPANY • MANSFIELD, OHIO
 GORMAN-RUPP OF CANADA LIMITED • ST. THOMAS, ONTARIO, CANADA
 www.grpumps.com

© Copyright by the Gorman-Rupp Company 2007

Specifications Subject to Change Without Notice

Printed in U.S.A.

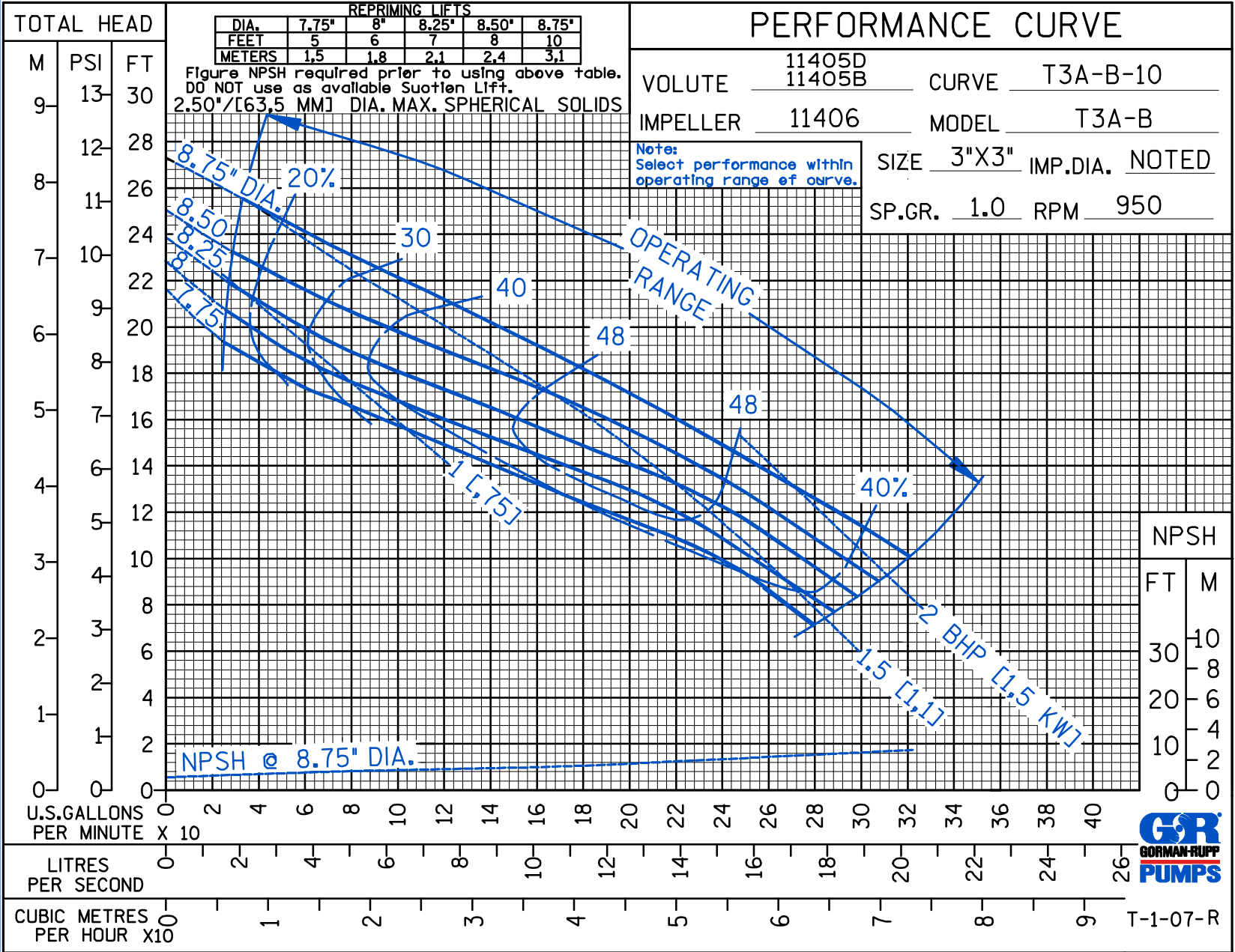

CDSW

Curve Data

Sec. 55

PAGE 2051.10
FEBRUARY 2007

D S W

PERFORMANCE CURVE

VOLUTE	11405D 11405B	CURVE	T3A-B-11
IMPELLER	11406	MODEL	T3A-B
NOTE: See single pump curve for horsepower, efficiency, & NPSH		SIZE	3"X3" IMP.DIA. 8.75"
		SP.GR.	1.0 RPM NOTED

2.50"/[63,5 MM] DIA. MAX. SPHERICAL SOLIDS CURVE FOR PARALLEL APPLICATION ONLY & SHOULD NOT BE USED FOR SINGLE PUMP PERFORMANCE

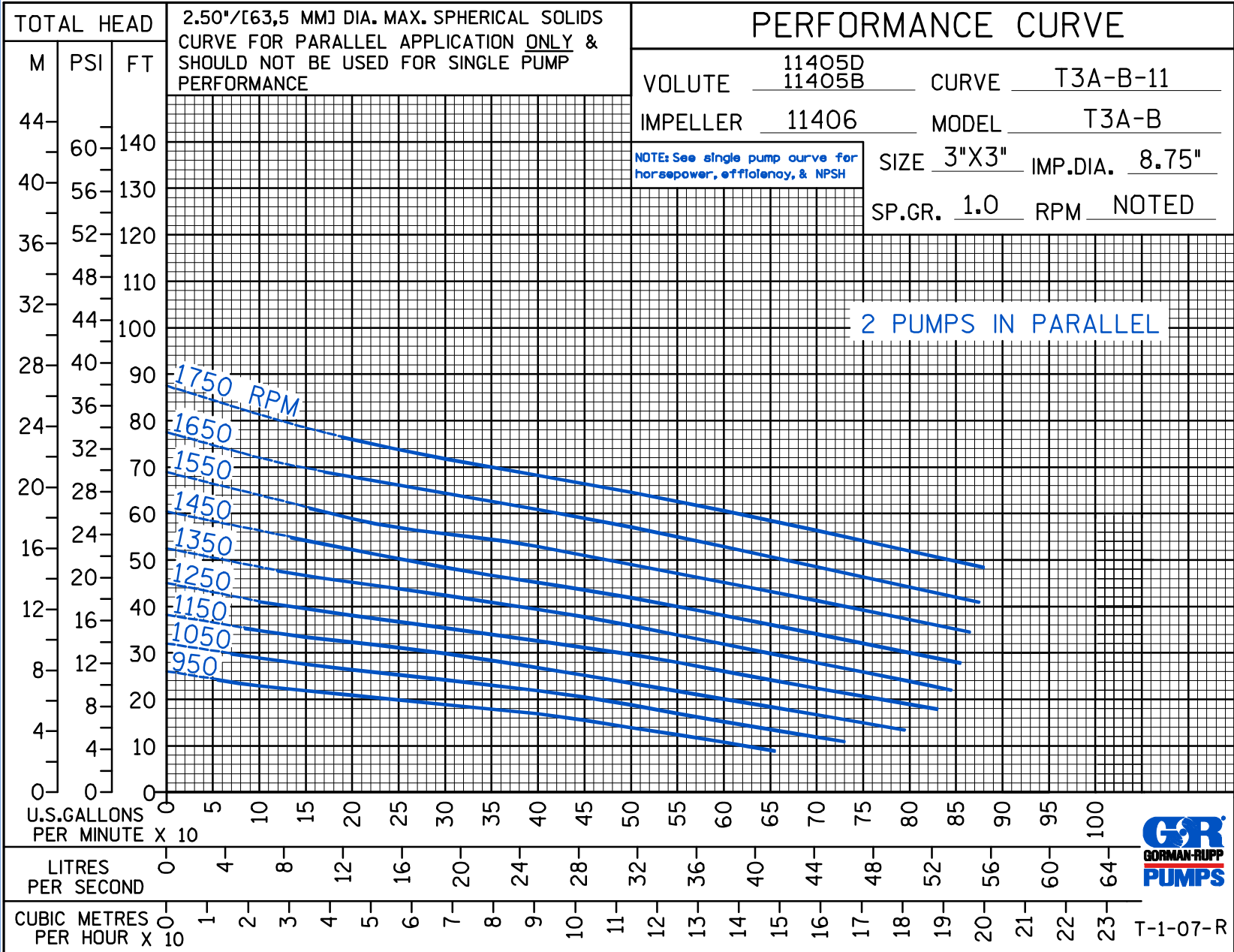

T-1-07-R



THE GORMAN-RUPP COMPANY • MANSFIELD, OHIO

GORMAN-RUPP OF CANADA LIMITED • ST. THOMAS, ONTARIO, CANADA

www.grpumps.com

Specifications Subject to Change Without Notice

Printed in U.S.A.

D S W

PERFORMANCE CURVE

VOLUTE 11405D CURVE T3A-B-12
 11405B
 IMPELLER 11406 MODEL T3A-B
 SIZE 3"X3" IMP.DIA. 8.75"
 SP.GR. 1.0 RPM NOTED

Performance shown does not include any interconnecting piping

NOTE: Series operation is limited by the operating pressure & NPSH requirement of a single pump. See single pump curve for NPSH, EFF., & HP.

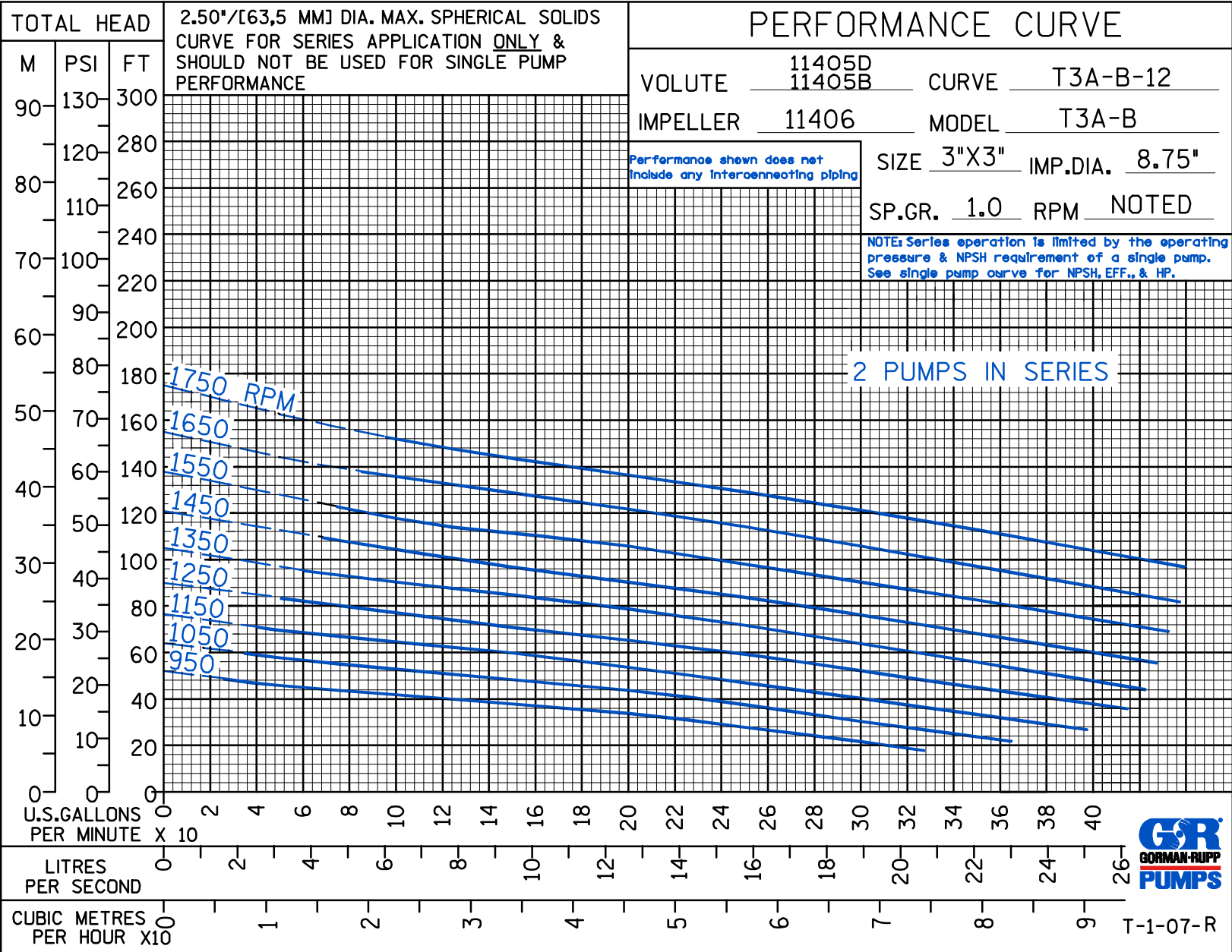

THE GORMAN-RUPP COMPANY • MANSFIELD, OHIO
 GORMAN-RUPP OF CANADA LIMITED • ST. THOMAS, ONTARIO, CANADA
 www.grpumps.com

Specifications Subject to Change Without Notice

Printed in U.S.A.