

Stainless Steel Fitted Basic Pump

CDS

Self Priming Centrifugal Pump

**Super
T SERIES**
VARIOUS PATENTS APPLY

Model T4A61S-B

Size 4" x 4"



PUMP SPECIFICATIONS

Size: 4" x 4" (101 mm x 101 mm) NPT - Female.**Casing:** Gray Iron 30.

Maximum Operating Pressure 86 psi (593 kPa).*

Semi-Open Type, Two Vane Impeller: Stainless Steel 316.

Handles 3" (76.2 mm) Diameter Spherical Solids.

Impeller Shaft: Stainless Steel 17-4 PH.**Replaceable Wear Plate:** Stainless Steel 316.**Removable Adjustable Cover Plate:** Gray Iron 30; 40 lbs. (18 kg).**Flap Valve:** Neoprene w/Nylon and Steel Reinforcing.**Seal Plate:** Stainless Steel 316.**Bearing Housing:** Gray Iron 30.**Radial Bearing:** Open Single Row Ball.**Thrust Bearing:** Open Double Row Ball.**Bearing and Seal Cavity Lubrication:** SAE 30 Non-Detergent Oil.**Flanges:** 125# Gray Iron 30.**Gaskets:** Buna-N, w/Compressed Synthetic Fibers, Vegetable Fiber, PTFE, Cork, and Rubber.**O-Rings:** Buna-N.**Internal Wetted Hardware:** Stainless Steel 316.**External Hardware:** Standard Plated Steel.**Pressure Relief Valve:** Stainless Steel 316.**Bearing and Seal Cavity Oil Level Sight Gauges.****Optional Equipment:** Metal Bellows Seal. Automatic Air Release Valve.

Stainless Steel CD4MCu Impeller, Seal Plate and Wear Plate.

120V/240V Casing Heater. High Pump Temperature Shutdown Kit.

Self-Cleaning Wear Plate.

Gray Iron 30 Suction and Discharge Spool Flanges:

4" ASA (**Specify Model T4A61S-B /F**).100 mm DIN 2527 (PN 16) (**Specify Model T4A61S-B /FM**).**Consult Factory for Applications Exceeding Maximum Pressure and/or Temperature Indicated.*

Shown with Optional Suction & Discharge Spool Flanges (Available in ASA or DIN Standard Sizes).

SEAL SPECIFICATIONS

Mechanical, Oil-Lubricated, Double Floating, Self-Aligning. Silicon Carbide Rotating and Stationary Faces. Stainless Steel 316 Stationary Seat. Fluorocarbon Elastomers (DuPont Viton® or Equivalent). Stainless Steel 18-8 Cage and Spring. Maximum Temperature of Liquid Pumped, 160°F (71°C).*

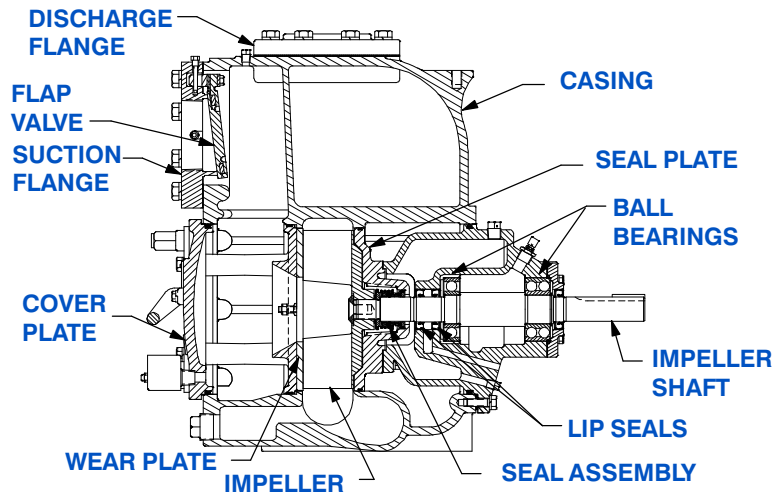

SEAL DETAIL

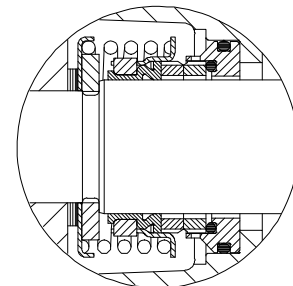

GR
GORMAN-RUPP
PUMPS

THE GORMAN-RUPP COMPANY • MANSFIELD, OHIO

GORMAN-RUPP OF CANADA LIMITED • ST. THOMAS, ONTARIO, CANADA

www.grpumps.com

Specifications Subject to Change Without Notice

Printed in U.S.A.

Specification Data

SECTION 55, PAGE 2120

APPROXIMATE DIMENSIONS and WEIGHTS

NET WEIGHT: 586 LBS. (266 KG.)
SHIPPING WEIGHT: 625 LBS. (283 KG.)
EXPORT CRATE: 22.7 CU. FT. (0,64 CU. M.)
***ADD 15 LBS. (6,8 KG.) W/EACH SPOOL FLANGE**

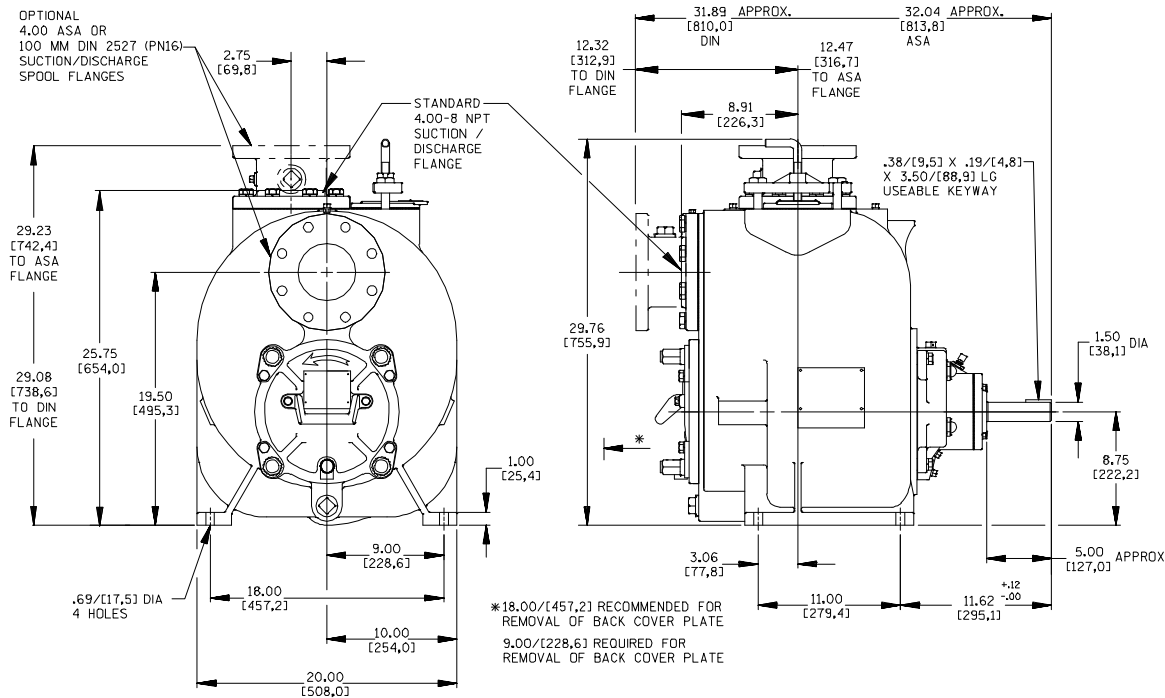

NOTE: OPTIONAL ASA OR DIN STANDARD SUCITON & DISCHARGE SPOOL FLANGES AVAILABLE.

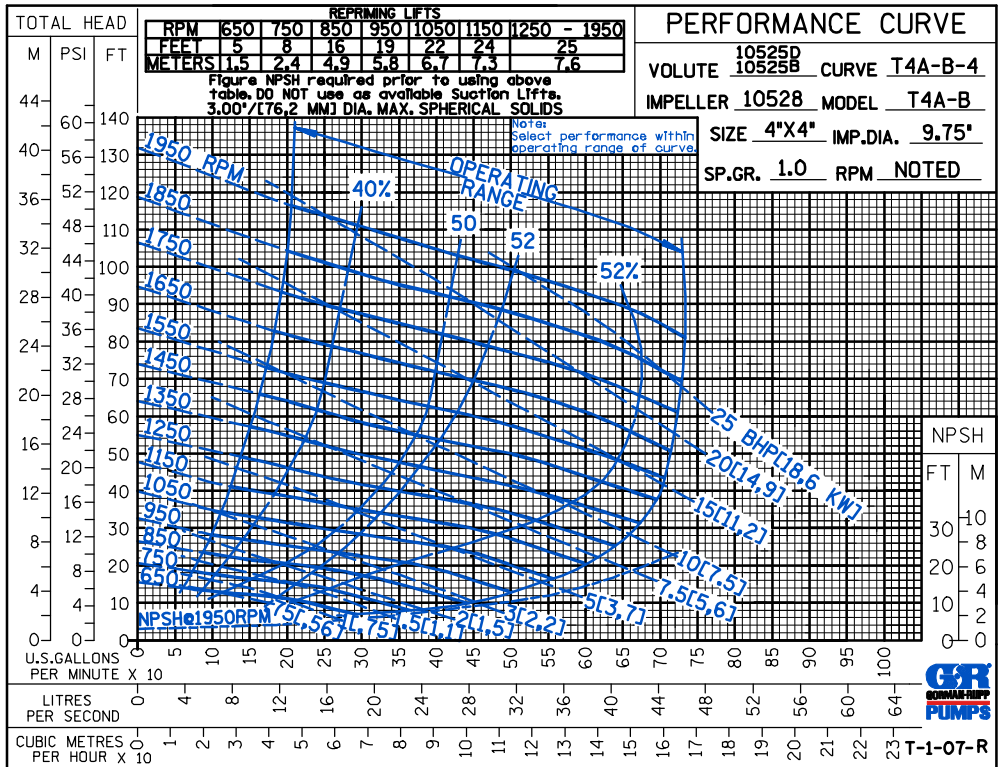

THE GORMAN-RUPP COMPANY • MANSFIELD, OHIO

GORMAN-RUPP OF CANADA LIMITED • ST. THOMAS, ONTARIO, CANADA

Specifications Subject to Change Without Notice

Printed in U.S.A.



THE GORMAN-RUPP COMPANY • MANSFIELD, OHIO

GORMAN-RUPP OF CANADA LIMITED • ST. THOMAS, ONTARIO, CANADA

www.grpmumps.com

Specifications Subject to Change Without Notice

Printed in U.S.A.

© Copyright by the Gorman-Rupp Company 2008

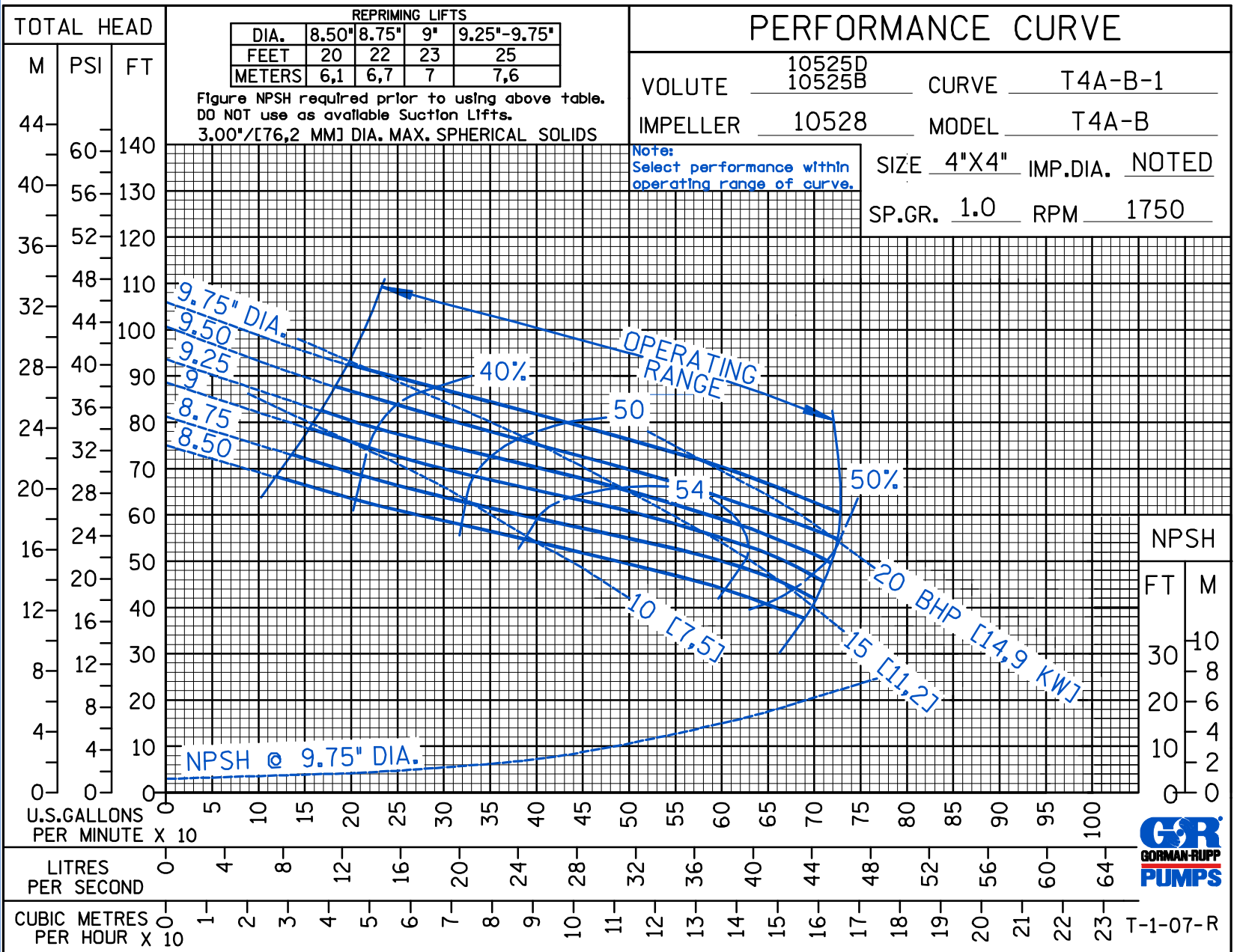

CDSW

Curve Data

Sec. 55

PAGE 2145.1
JULY 2008



T-1-07-R

CDSW

PERFORMANCE CURVE

VOLUTE 10525D
10525B CURVE T4A-B-2

IMPELLER 10528 MODEL T4A-B

SIZE 4"X4" IMP.DIA. NOTED

SP.GR. 1.0 RPM 1150

REPRIMING LIFTS						
DIA.	8.50"	8.75"	9"	9.25"	9.50"	9.75"
FEET	9	10	13	16	22	24
METERS	2,7	3,1	4	4,9	6,7	7,3

Figure NPSH required prior to using above table. DO NOT use as available Suction Lifts.

3.00"/[76,2 MM] DIA. MAX. SPHERICAL SOLIDS

Note:
Select performance within operating range of curve.

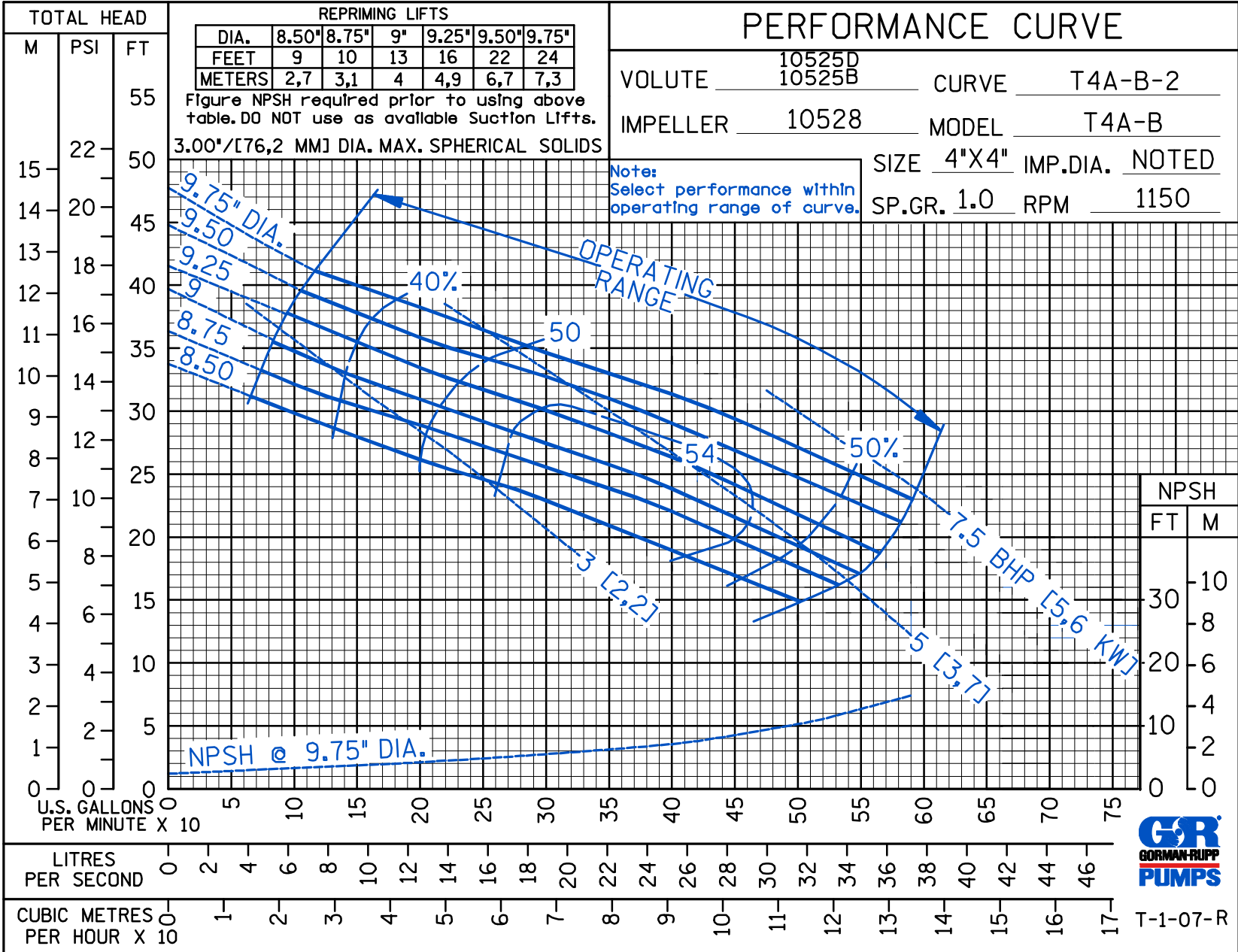

T-1-07-R



THE GORMAN-RUPP COMPANY • MANSFIELD, OHIO
GORMAN-RUPP OF CANADA LIMITED • ST. THOMAS, ONTARIO, CANADA

www.grpumps.com
Specifications Subject to Change Without Notice

Printed in U.S.A.



THE GORMAN-RUPP COMPANY • MANSFIELD, OHIO

GORMAN-RUPP OF CANADA LIMITED • ST. THOMAS, ONTARIO, CANADA

www.grpmumps.com

Specifications Subject to Change Without Notice

Printed in U.S.A.

© Copyright by the Gorman-Rupp Company 2008

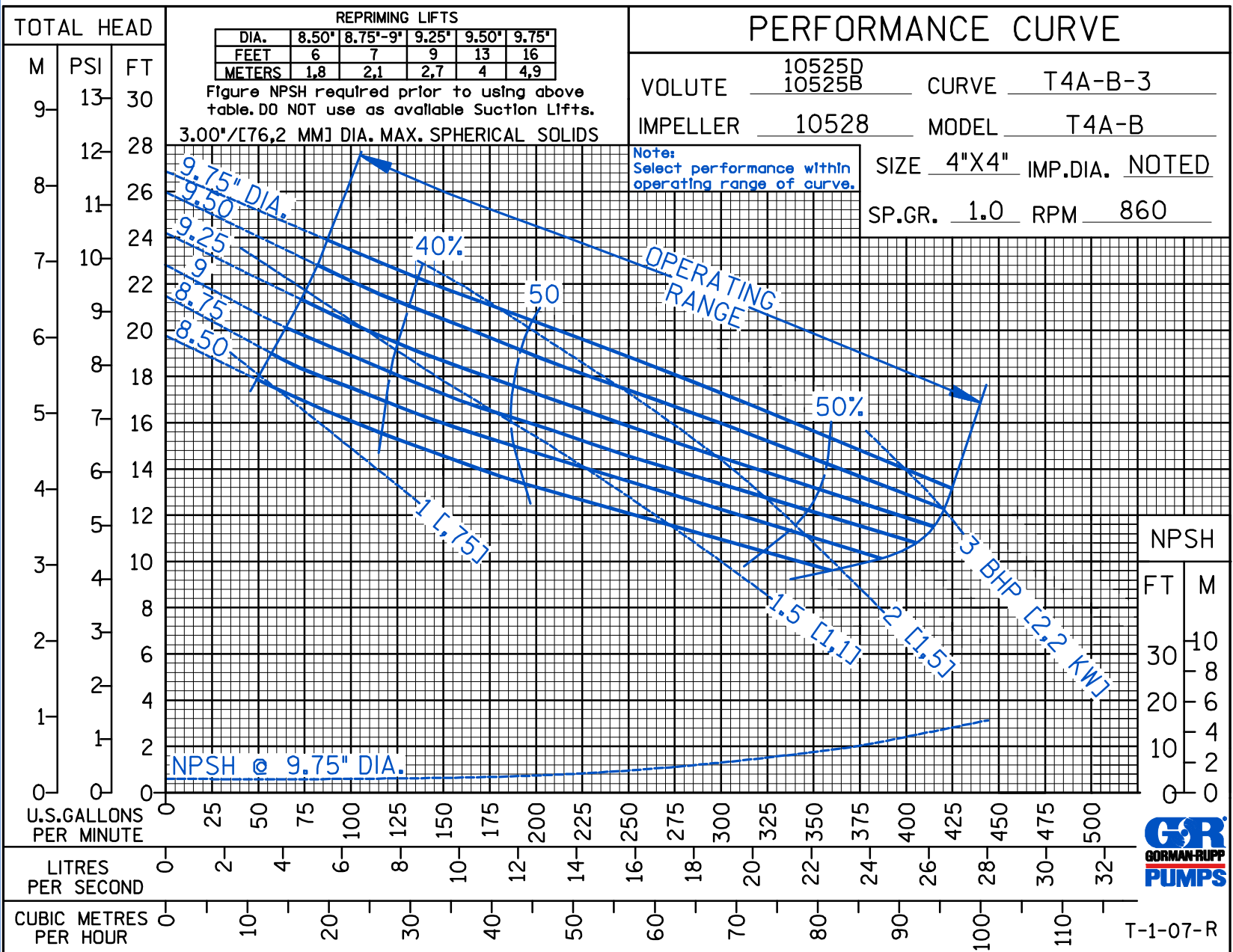

CDSW

Curve Data

Sec. 55

PAGE 2145.3
JULY 2008



THE GORMAN-RUPP COMPANY • MANSFIELD, OHIO
 GORMAN-RUPP OF CANADA LIMITED • ST. THOMAS, ONTARIO, CANADA
 www.grpumps.com
 Specifications Subject to Change Without Notice

© Copyright by the Gorman-Rupp Company 2008

Printed in U.S.A.

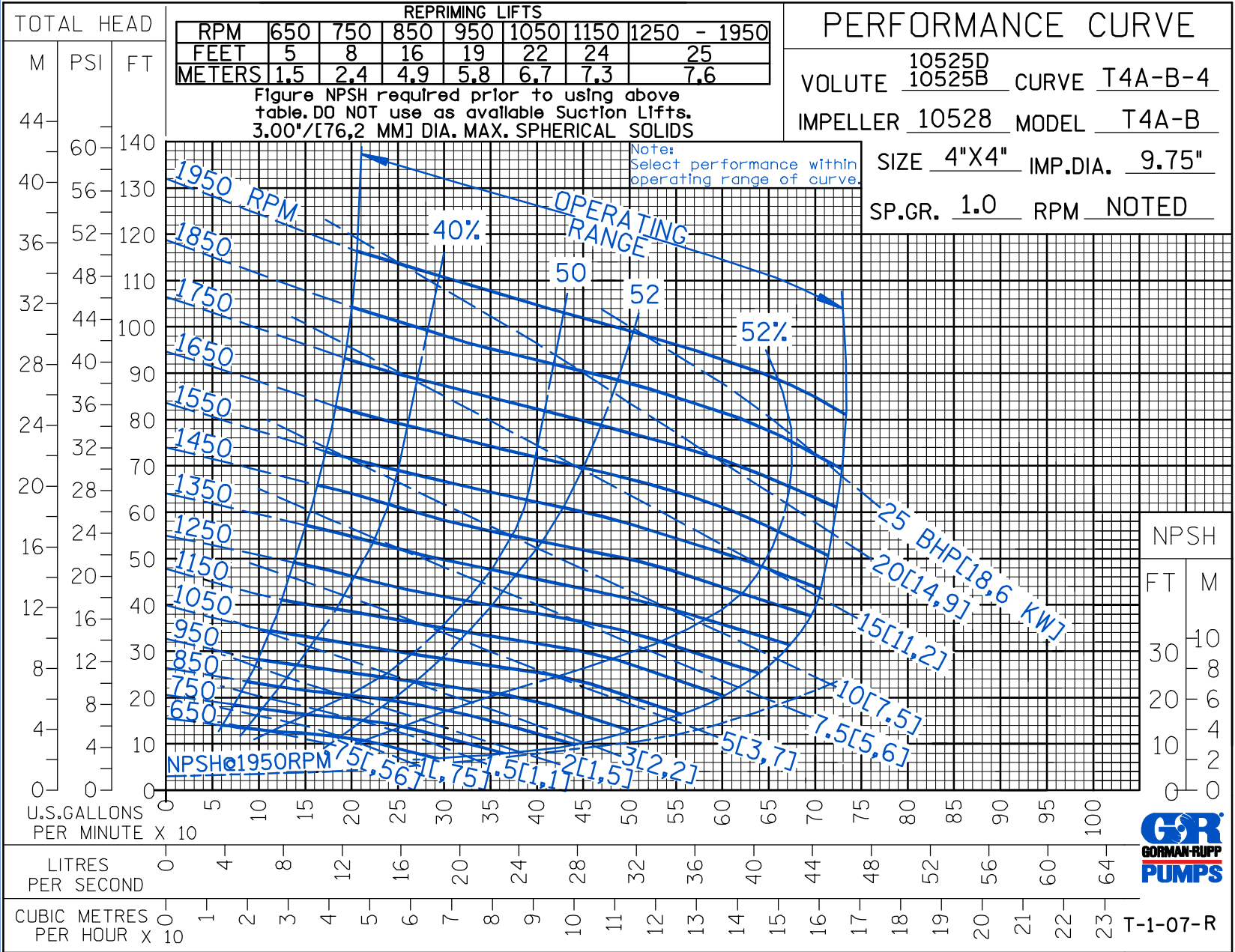

CDSW

Curve Data

Sec. 55

PAGE 2145.4
 JULY 2008



THE GORMAN-RUPP COMPANY • MANSFIELD, OHIO

GORMAN-RUPP OF CANADA LIMITED • ST. THOMAS, ONTARIO, CANADA

www.grpumps.com

Specifications Subject to Change Without Notice

Printed in U.S.A.

© Copyright by the Gorman-Rupp Company 2008

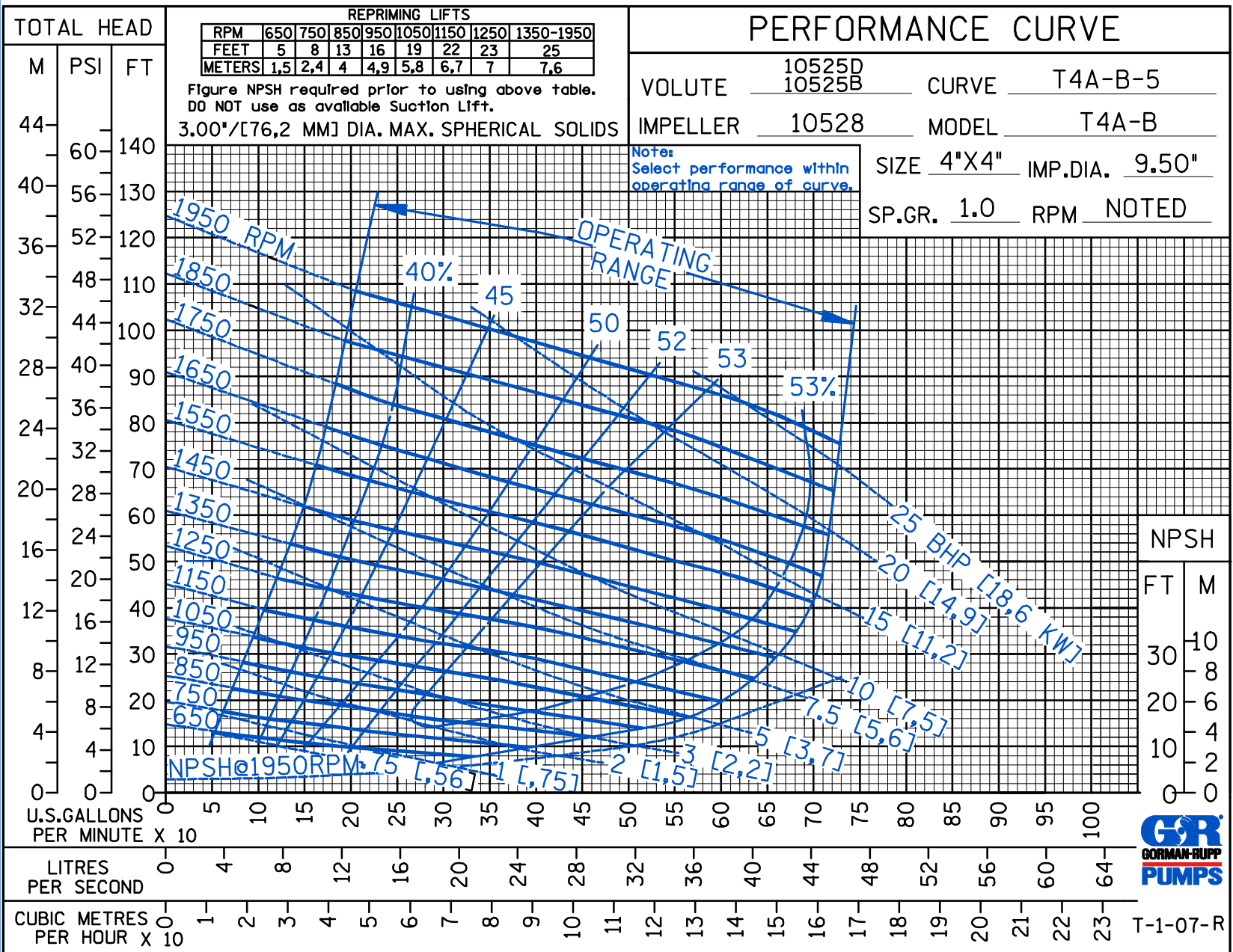

Curve Data

Sec. 55

PAGE 2145.5
JULY 2008

CDSW



T-1-07-R



THE GORMAN-RUPP COMPANY • MANSFIELD, OHIO
 GORMAN-RUPP OF CANADA LIMITED • ST. THOMAS, ONTARIO, CANADA
 www.grpumps.com

© Copyright by the Gorman-Rupp Company 2008

Specifications Subject to Change Without Notice

Printed in U.S.A.

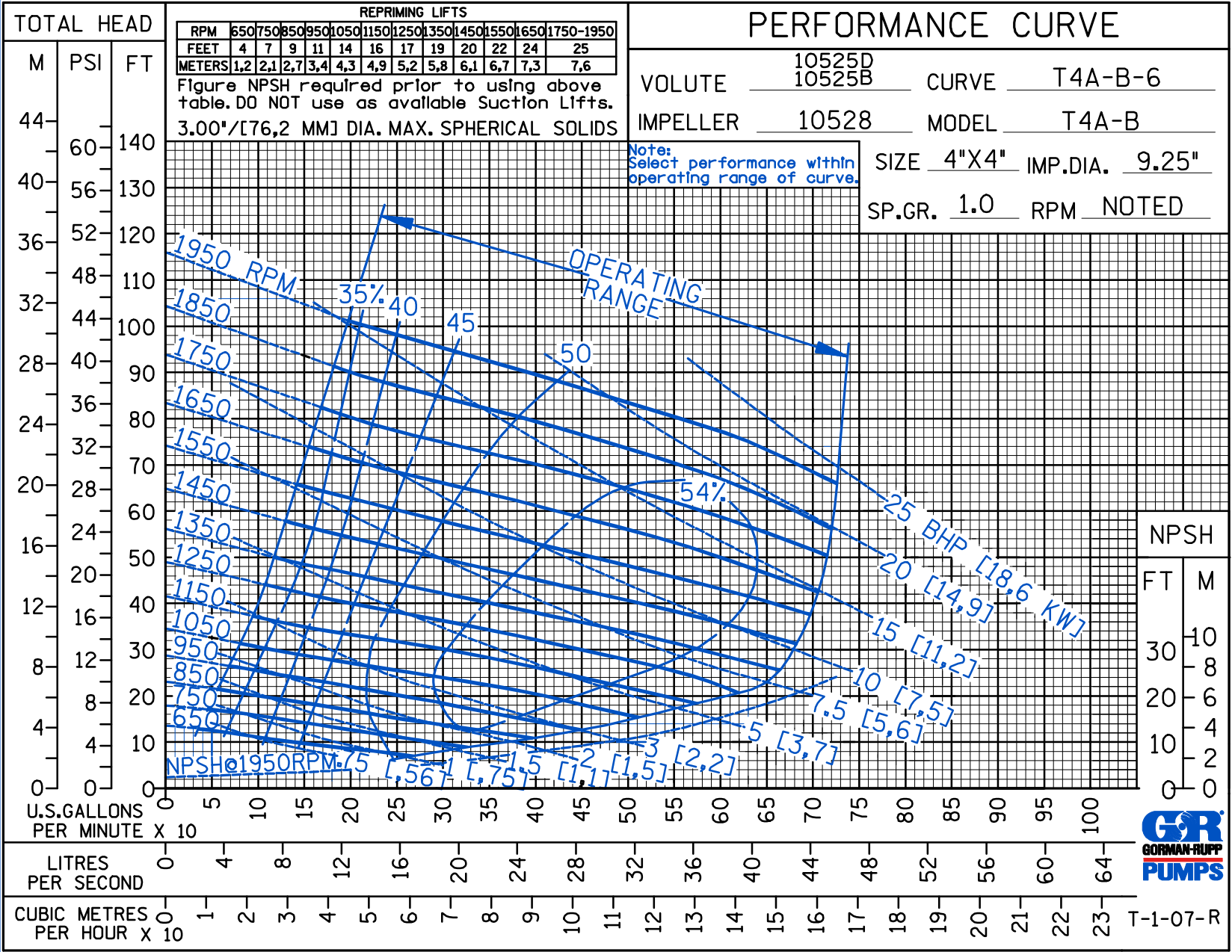

CDSW

Curve Data

Sec. 55

PAGE 2145.6
 JULY 2008



THE GORMAN-RUPP COMPANY • MANSFIELD, OHIO

GORMAN-RUPP OF CANADA LIMITED • ST. THOMAS, ONTARIO, CANADA

www.grpumps.com

Specifications Subject to Change Without Notice

Printed in U.S.A.

© Copyright by the Gorman-Rupp Company 2008

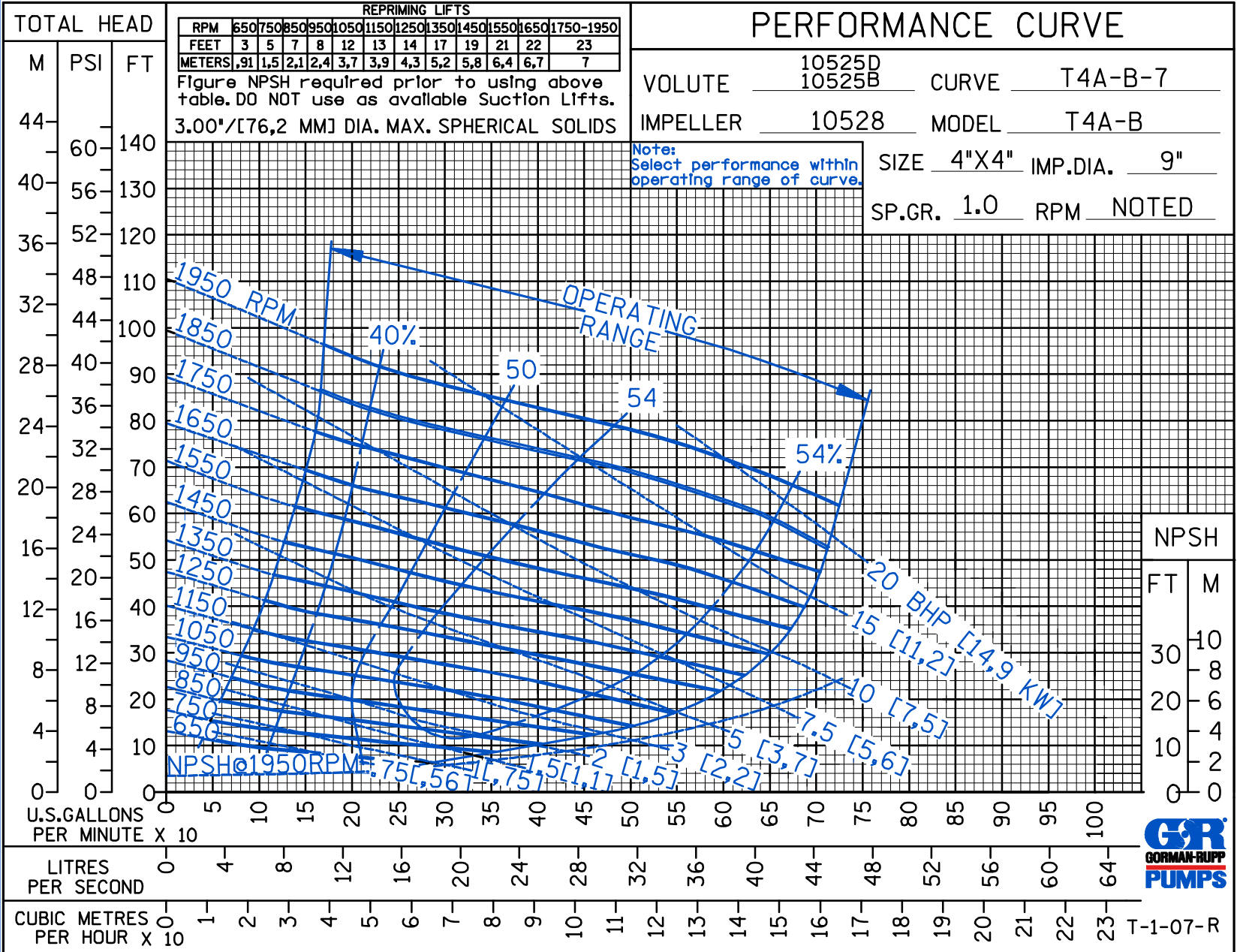

CDSW

Curve Data

Sec. 55

PAGE 2145.7
JULY 2008



T-1-07-R



THE GORMAN-RUPP COMPANY • MANSFIELD, OHIO
 GORMAN-RUPP OF CANADA LIMITED • ST. THOMAS, ONTARIO, CANADA
 www.grpumps.com

© Copyright by the Gorman-Rupp Company 2008

Specifications Subject to Change Without Notice

Printed in U.S.A.

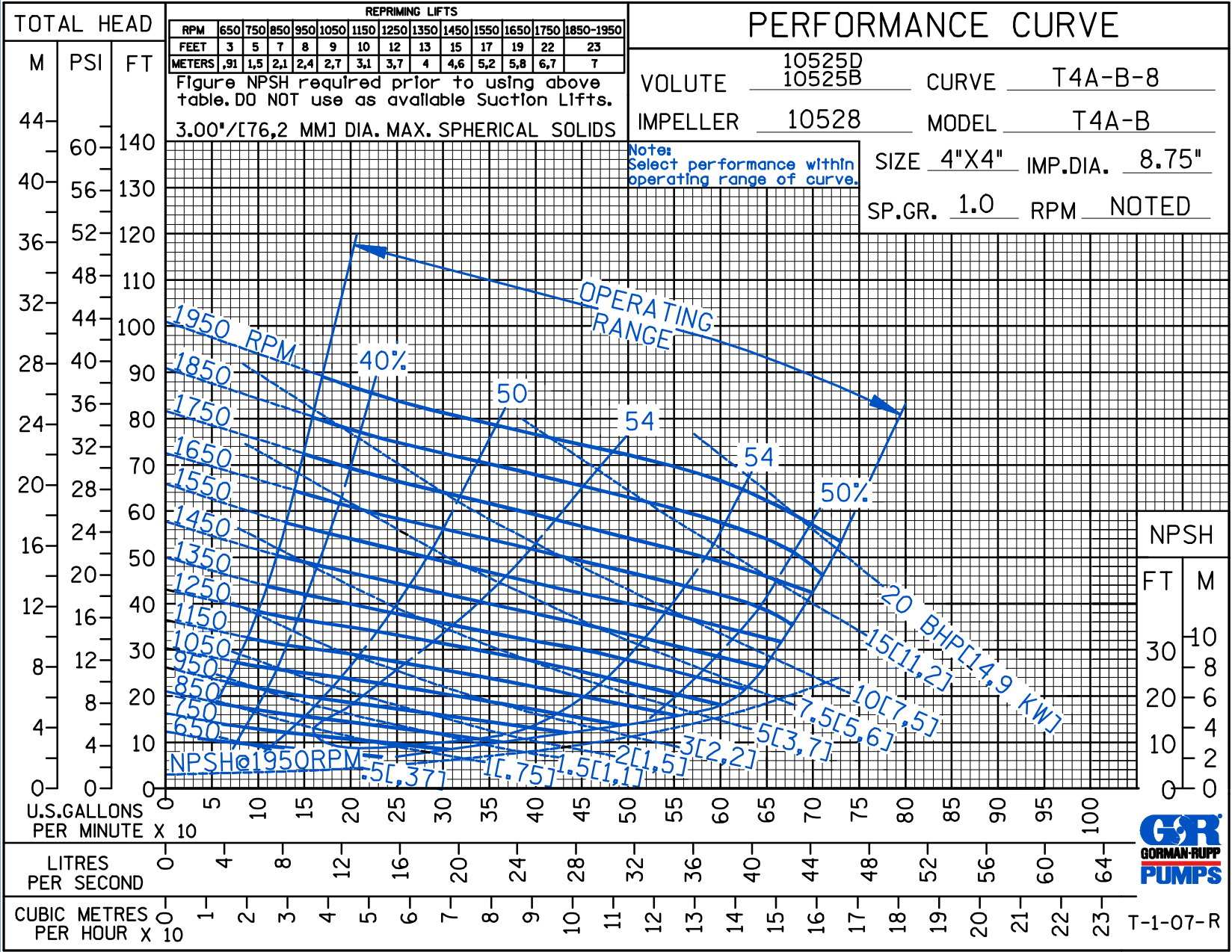

CDSW

Curve Data

Sec. 55

PAGE 2145.8
JULY 2008



THE GORMAN-RUPP COMPANY • MANSFIELD, OHIO

GORMAN-RUPP OF CANADA LIMITED • ST. THOMAS, ONTARIO, CANADA

www.grpumps.com

Specifications Subject to Change Without Notice

Printed in U.S.A.

© Copyright by the Gorman-Rupp Company 2008

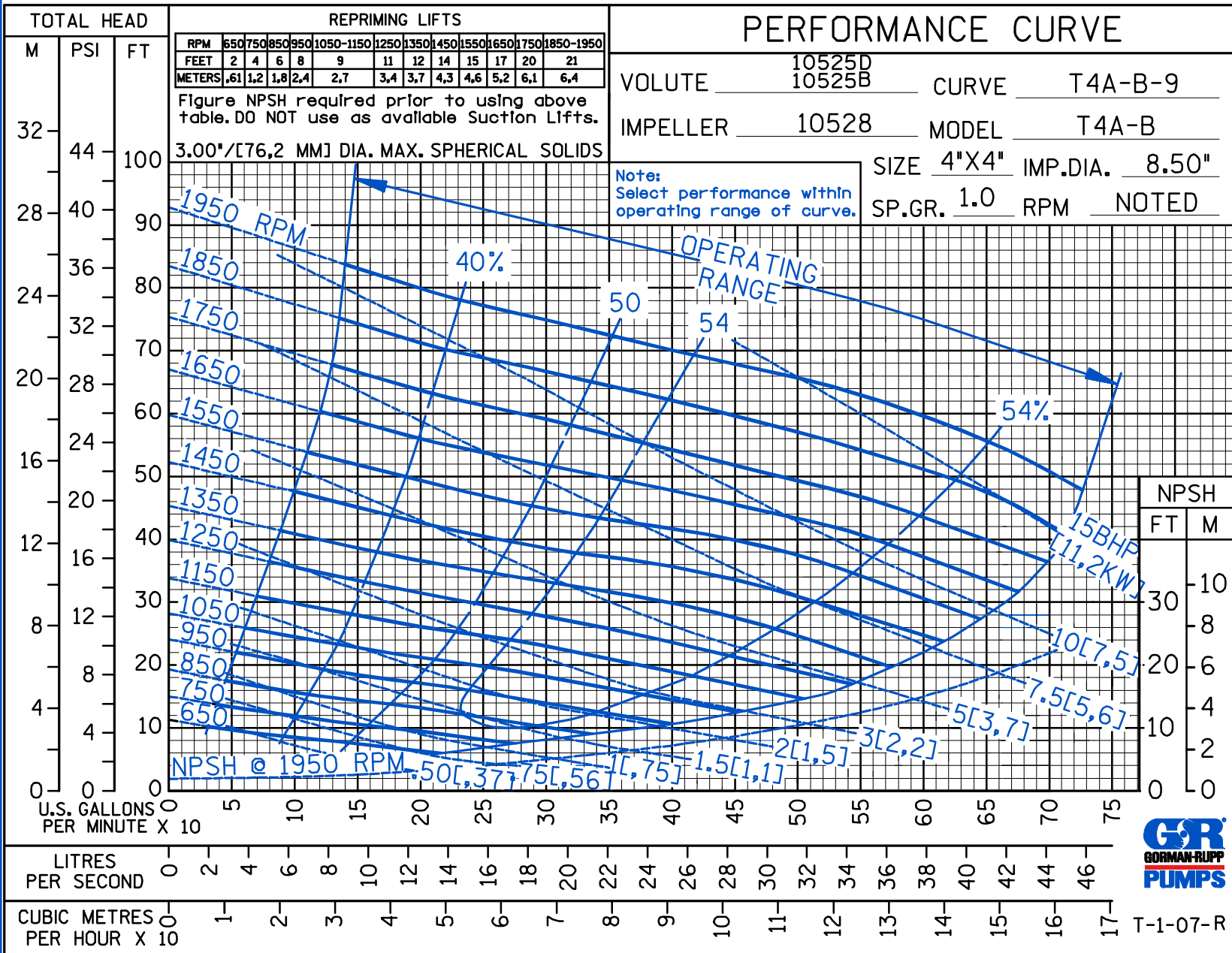

CDSW

Curve Data

Sec. 55

PAGE 2145.9
JULY 2008



THE GORMAN-RUPP COMPANY • MANSFIELD, OHIO
 GORMAN-RUPP OF CANADA LIMITED • ST. THOMAS, ONTARIO, CANADA
 www.grpumps.com

© Copyright by the Gorman-Rupp Company 2008

Specifications Subject to Change Without Notice

Printed in U.S.A.

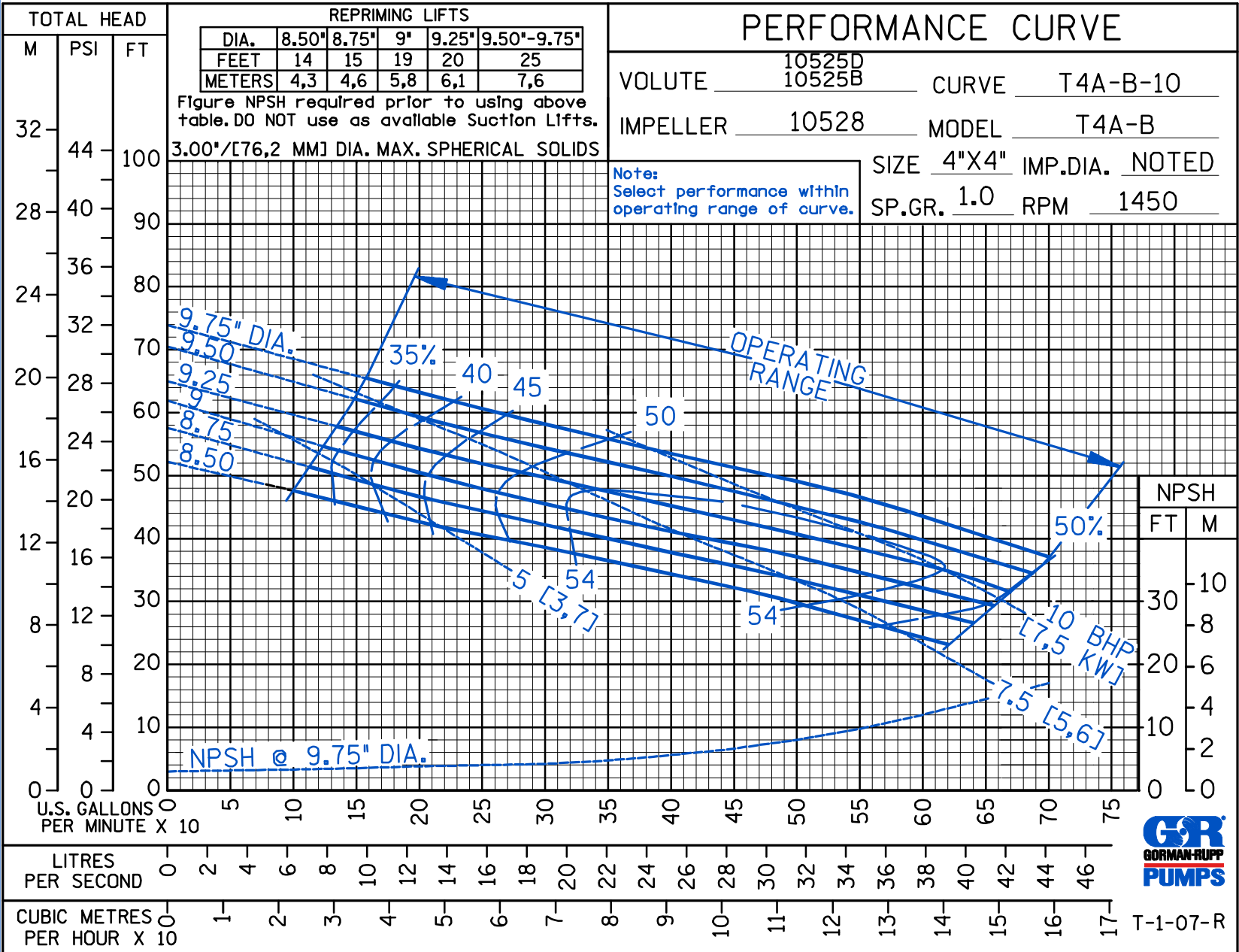

CDSW

Curve Data

Sec. 55

PAGE 2145.10
JULY 2008



T-1-07-R



THE GORMAN-RUPP COMPANY • MANSFIELD, OHIO

GORMAN-RUPP OF CANADA LIMITED • ST. THOMAS, ONTARIO, CANADA

www.grpmumps.com

Specifications Subject to Change Without Notice

Printed in U.S.A.

© Copyright by the Gorman-Rupp Company 2008

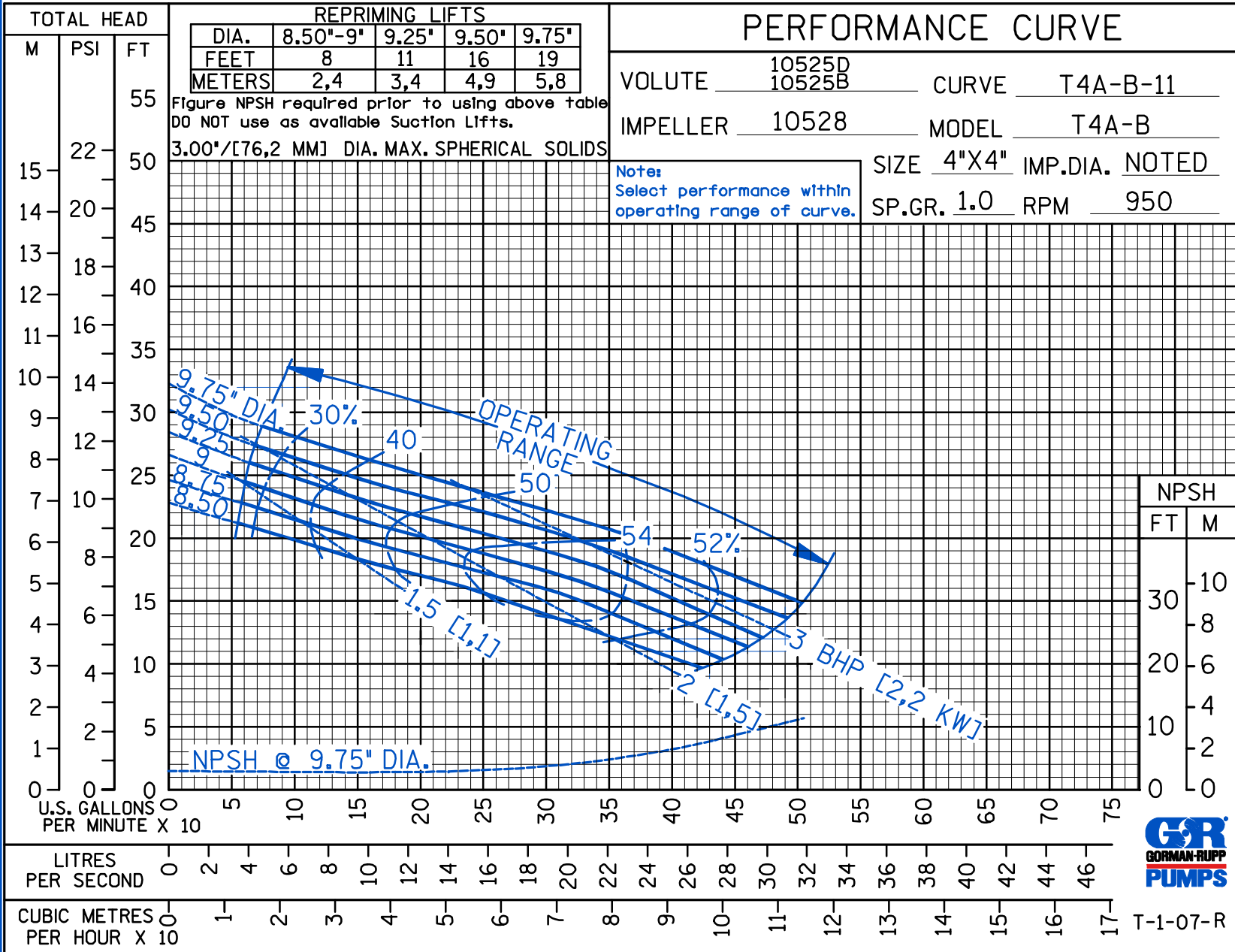

Curve Data

Sec. 55

PAGE 2145.11
JULY 2008

CDSW

D S W

PERFORMANCE CURVE

VOLUTE	10525D 10525B	CURVE	T4A-B-12
IMPELLER	10528	MODEL	T4A-B
		SIZE	4"X4" IMP.DIA. 9.75"
		SP.GR.	1.0 RPM NOTED

NOTE: See single pump curve for horsepower, efficiency, & NPSH

2 PUMPS IN PARALLEL

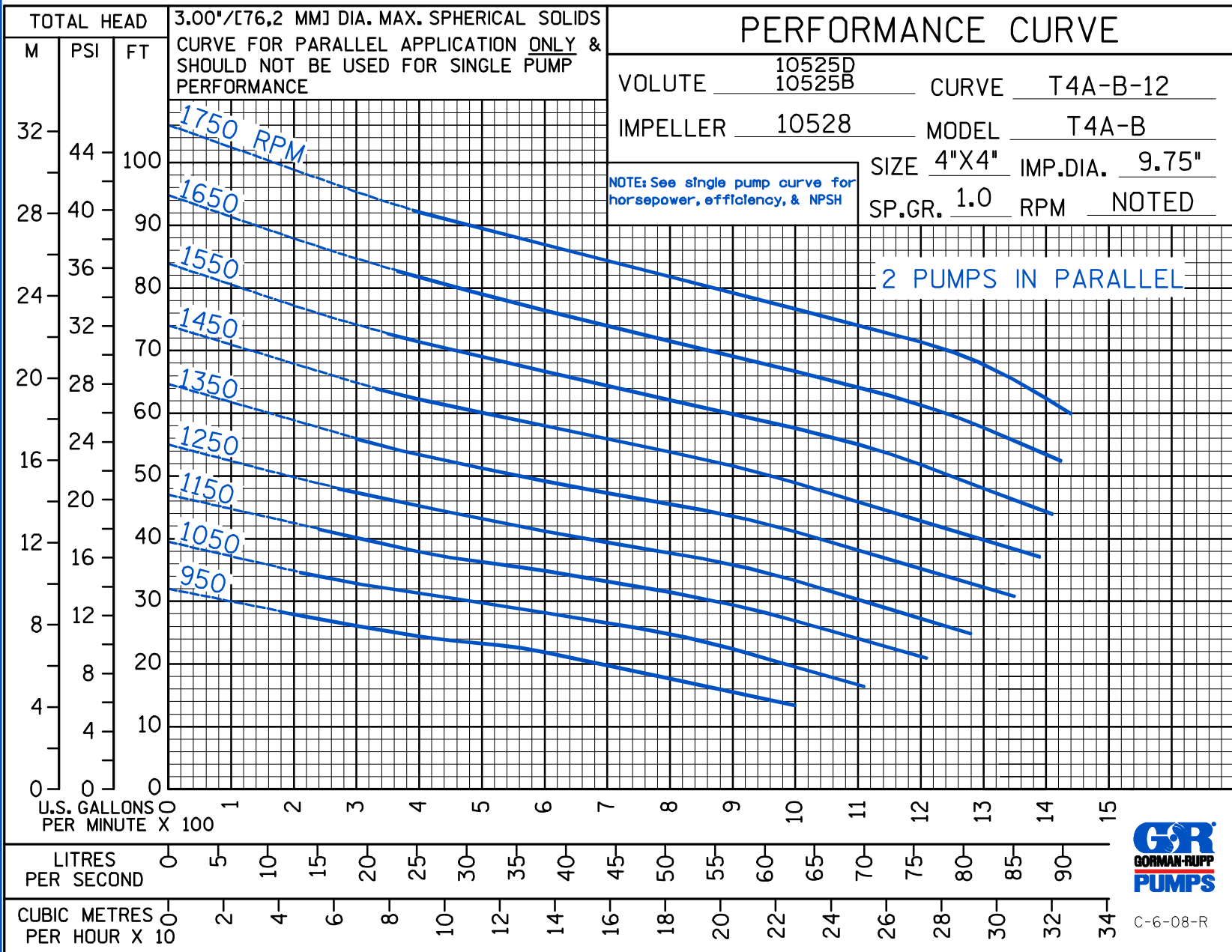

C-6-08-R



THE GORMAN-RUPP COMPANY • MANSFIELD, OHIO
GORMAN-RUPP OF CANADA LIMITED • ST. THOMAS, ONTARIO, CANADA

www.grpumps.com
Specifications Subject to Change Without Notice

Printed in U.S.A.



THE GORMAN-RUPP COMPANY • MANSFIELD, OHIO

GORMAN-RUPP OF CANADA LIMITED • ST. THOMAS, ONTARIO, CANADA

www.grpmumps.com

Specifications Subject to Change Without Notice

Printed in U.S.A.

© Copyright by the Gorman-Rupp Company 2008

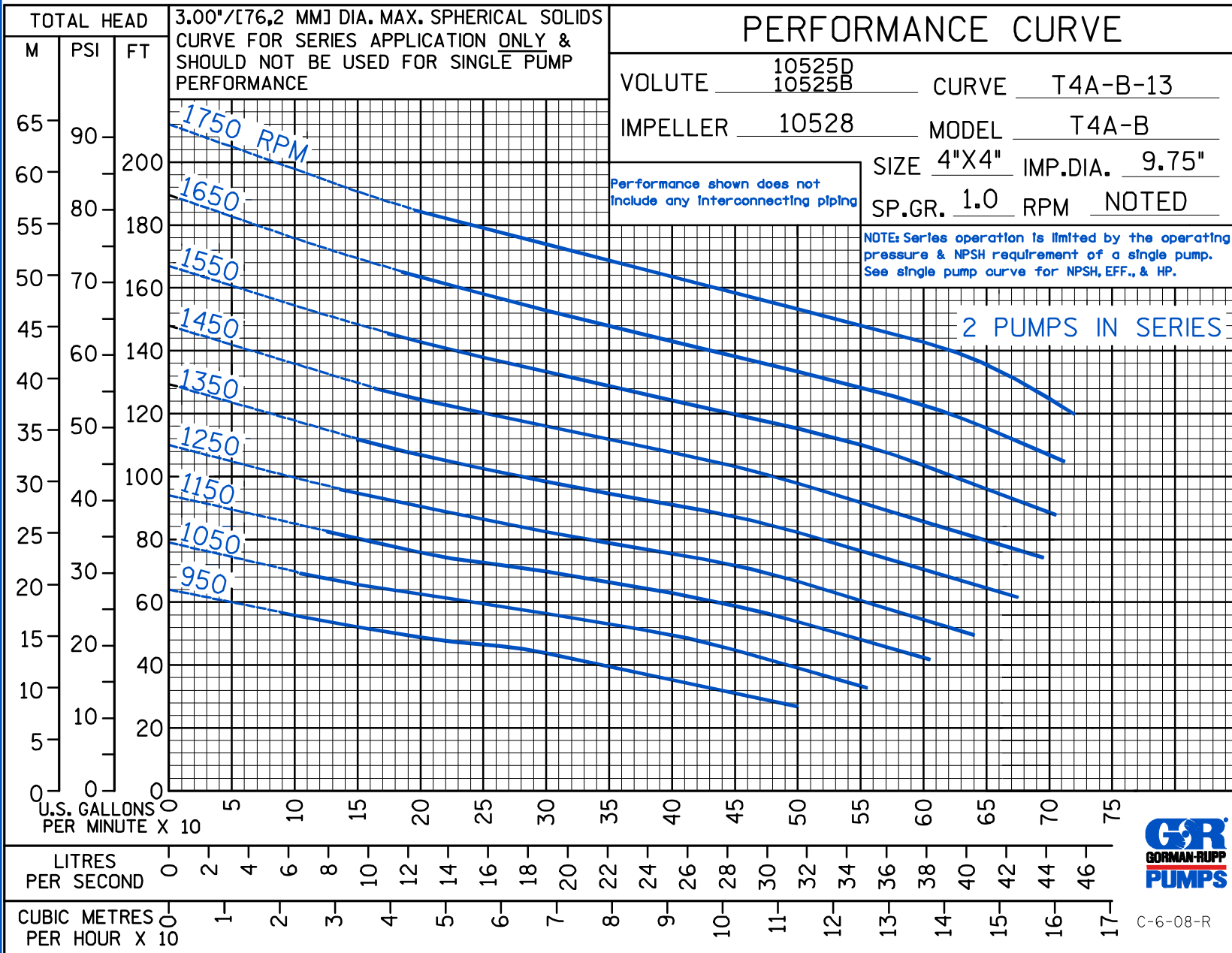

D S W

Curve Data

Sec. 55

PAGE 2145.13
JULY 2008



C-6-08-R