

CDSW

Self Priming Centrifugal Pump

**Super
T SERIES**

VARIOUS PATENTS APPLY

Model T4A71S-B**Size 4" x 4"****PUMP SPECIFICATIONS****Size:** 4" x 4" (101 mm x 101 mm) NPT - Female.**Casing:** Gray Iron 30.

Maximum Operating Pressure 86 psi (593 kPa).*

Semi-Open Type, Two Vane Impeller: G-R Hard Iron.

Handles 3" (76,2 mm) Diameter Spherical Solids.

Impeller Shaft: Alloy Steel 4150.**Shaft Sleeve:** Alloy Steel 4130.**Replaceable Wear Plate:** Hardened Alloy Steel.**Removable Adjustable Cover Plate:** Gray Iron 30; 41 lbs. (18 kg).**Flap Valve:** Neoprene w/Nylon and Steel Reinforcing.**Seal Plate:** G-R Hard Iron.**Bearing Housing:** Gray Iron 30.**Radial Bearing:** Open Single Row Ball.**Thrust Bearing:** Open Double Row Ball.**Bearing and Seal Cavity Lubrication:** SAE 30 Non-Detergent Oil.**Flanges:** 125# Gray Iron 30.**Gaskets:** Buna-N, Compressed Synthetic Fibers, Vegetable Fiber, PTFE, Cork, and Rubber.**O-Rings:** Buna-N.**Hardware:** Standard Plated Steel.**Brass Pressure Relief Valve.****Bearing and Seal Cavity Oil Level Sight Gauges.****Optional Equipment:** Metal Bellows Seal. Automatic Air Release Valve. 120V/240V Casing Heater. High Pump Temperature Shutdown Kit. G-R Hard Iron Casing. Self-Cleaning Wear Plate. Gray Iron 30 Suction and Discharge Spool Flanges:4" ASA (**Specify Model T4A71S-B /F**).100 mm DIN 2527 (PN 16) (**Specify Model T4A71SB /FM**).**Consult Factory for Applications Exceeding Maximum Pressure and/or Temperature Indicated.***Shown with Optional Suction & Discharge Spool Flanges (Available in ASA or DIN Standard Sizes).****SEAL SPECIFICATIONS**

Cartridge Type, Mechanical, Oil-Lubricated, Double Floating, Self-Aligning. Silicon Carbide Rotating and Stationary Faces. Stainless Steel 316 Stationary Seat. Fluorocarbon Elastomers (DuPont Viton® or Equivalent). Stainless Steel 18-8 Cage and Spring. Maximum Temperature of Liquid Pumped, 160°F (71°C).*

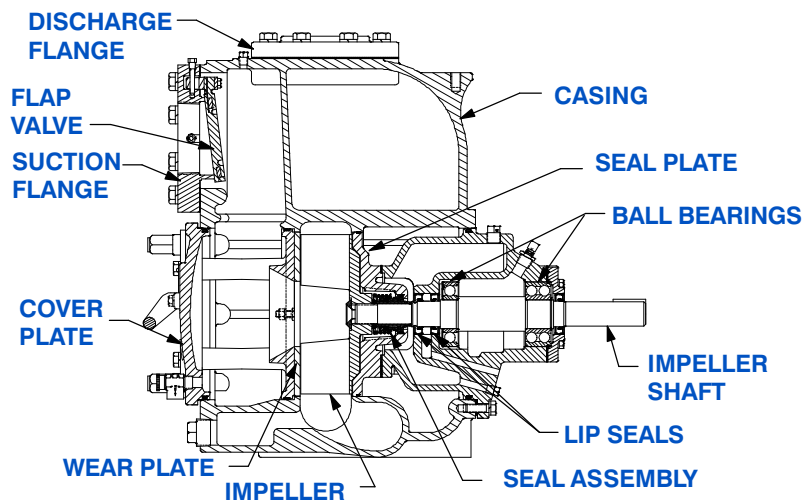
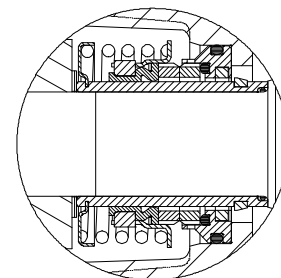
**SEAL DETAIL****GR**
GORMAN-RUPP
PUMPS**THE GORMAN-RUPP COMPANY • MANSFIELD, OHIO**

GORMAN-RUPP OF CANADA LIMITED • ST. THOMAS, ONTARIO, CANADA

www.grpumps.com

Specifications Subject to Change Without Notice

Printed in U.S.A.

Specification Data

SECTION 55, PAGE 2140

APPROXIMATE DIMENSIONS and WEIGHTS

NET WEIGHT: 585 LBS. (265 KG.)*
SHIPPING WEIGHT: 624 LBS. (283 KG.)*
EXPORT CRATE: 22.7 CU. FT. (0,64 CU. M.)
***ADD 15 LBS. (6,8 KG.) W/EACH SPOOL FLANGE**

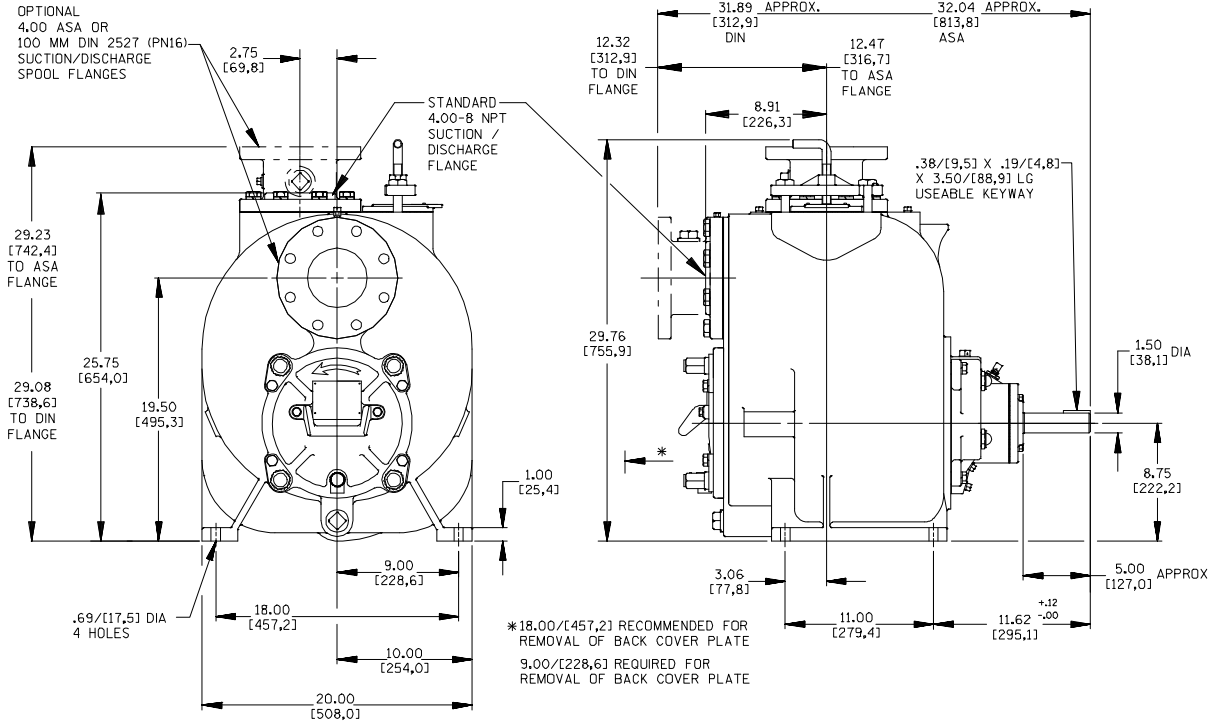

OPTIONAL ASA OR DIN STANDARD SUCTION & DISCHARGE SPOOL FLANGES AVAILABLE

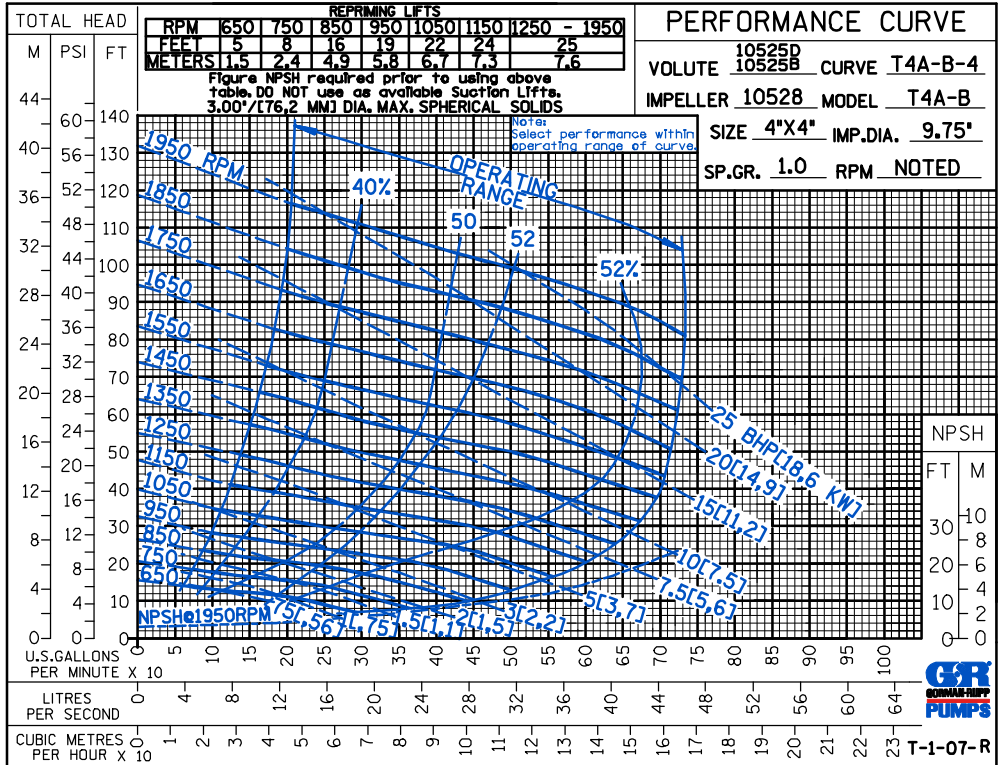

THE GORMAN-RUPP COMPANY • MANSFIELD, OHIO

GORMAN-RUPP OF CANADA LIMITED • ST. THOMAS, ONTARIO, CANADA

Specifications Subject to Change Without Notice

Printed in U.S.A.



THE GORMAN-RUPP COMPANY • MANSFIELD, OHIO

GORMAN-RUPP OF CANADA LIMITED • ST. THOMAS, ONTARIO, CANADA

www.grpumps.com

Specifications Subject to Change Without Notice

Printed in U.S.A.

© Copyright by the Gorman-Rupp Company 2008

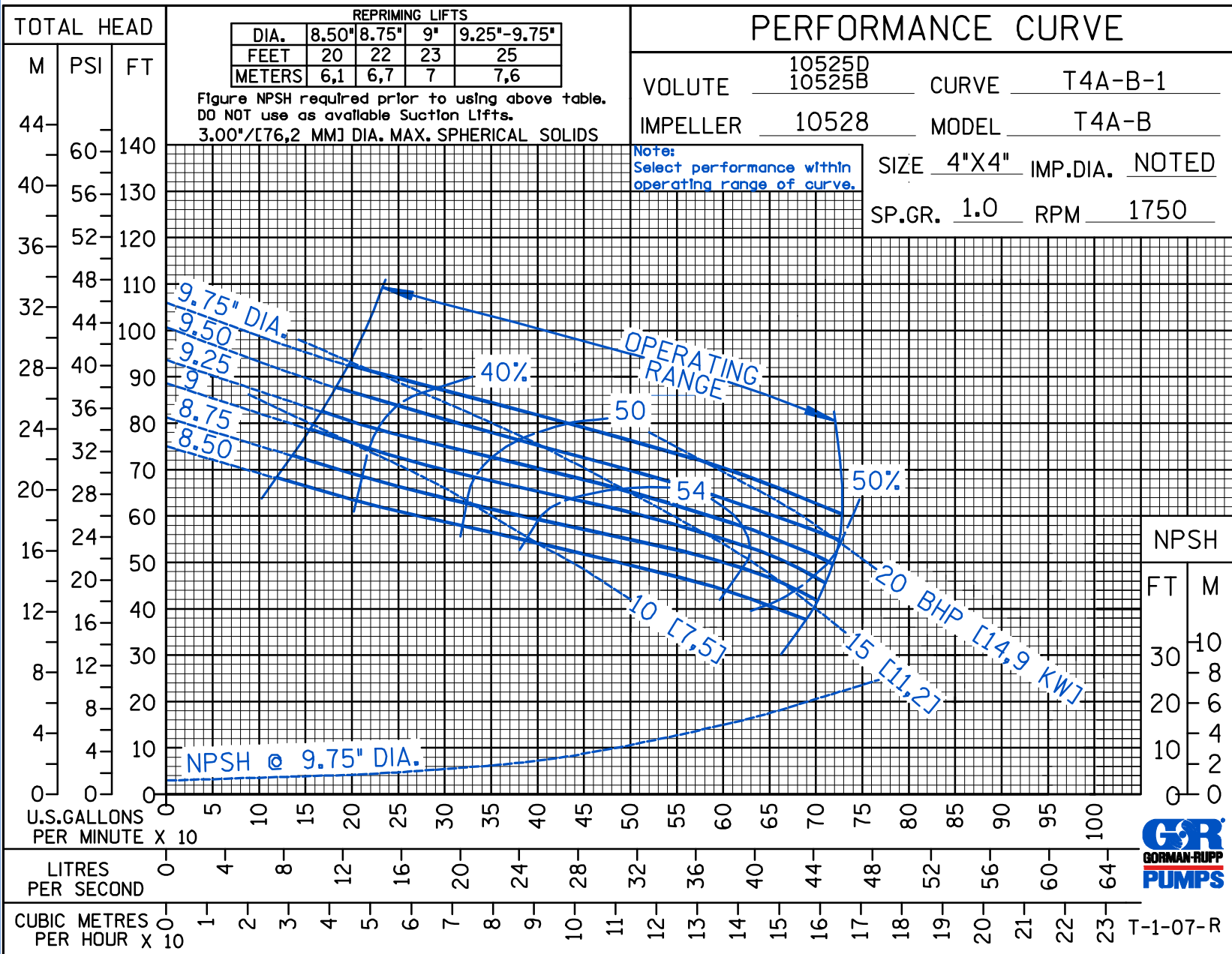

CDSW

Curve Data

Sec. 55

PAGE 2145.1
JULY 2008



T-1-07-R



THE GORMAN-RUPP COMPANY • MANSFIELD, OHIO
 GORMAN-RUPP OF CANADA LIMITED • ST. THOMAS, ONTARIO, CANADA
 www.grpumps.com

© Copyright by the Gorman-Rupp Company 2008

Specifications Subject to Change Without Notice

Printed in U.S.A.

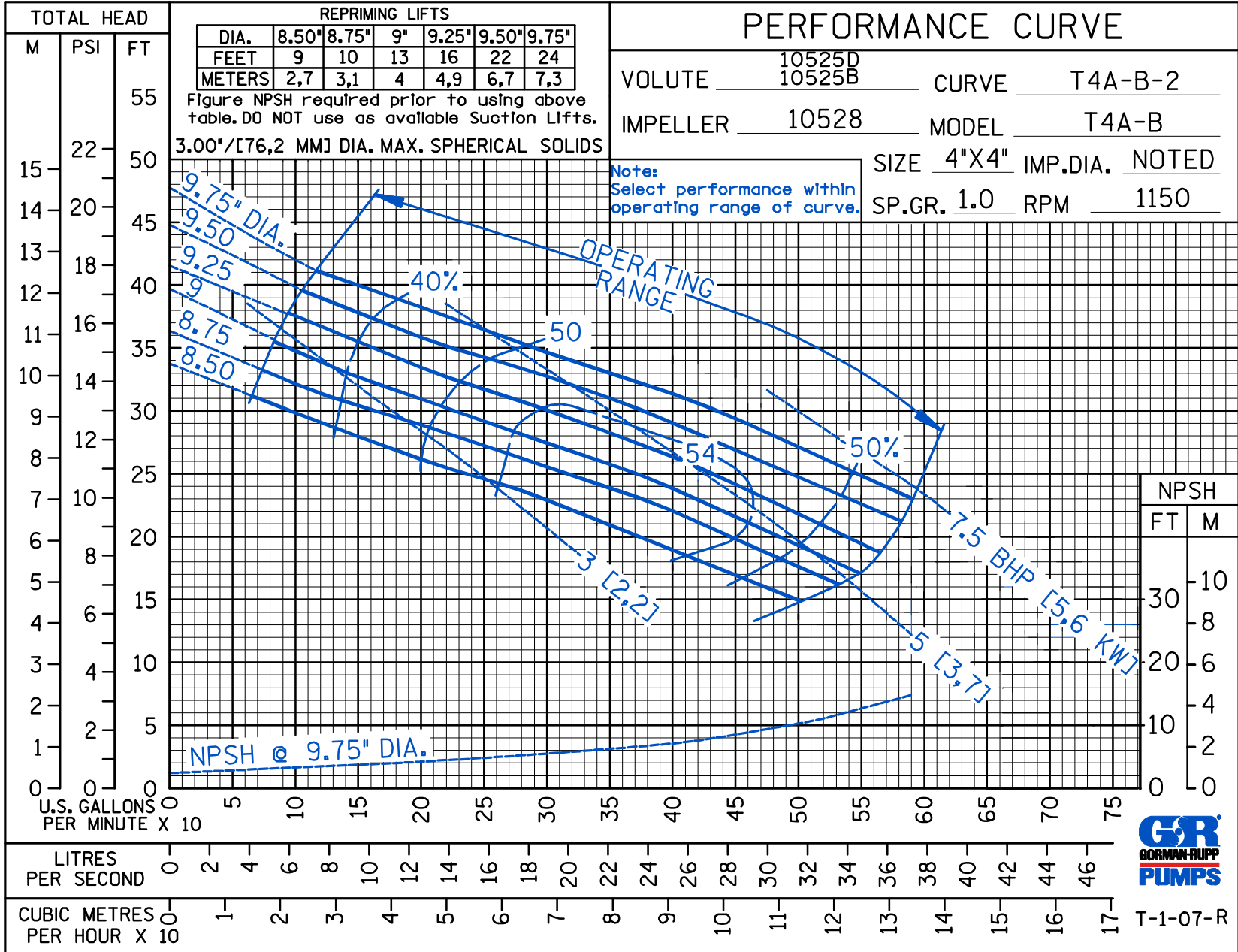

CDSW

Curve Data

Sec. 55

PAGE 2145.2
JULY 2008



THE GORMAN-RUPP COMPANY • MANSFIELD, OHIO

GORMAN-RUPP OF CANADA LIMITED • ST. THOMAS, ONTARIO, CANADA

www.grpmumps.com

Specifications Subject to Change Without Notice

Printed in U.S.A.

© Copyright by the Gorman-Rupp Company 2008

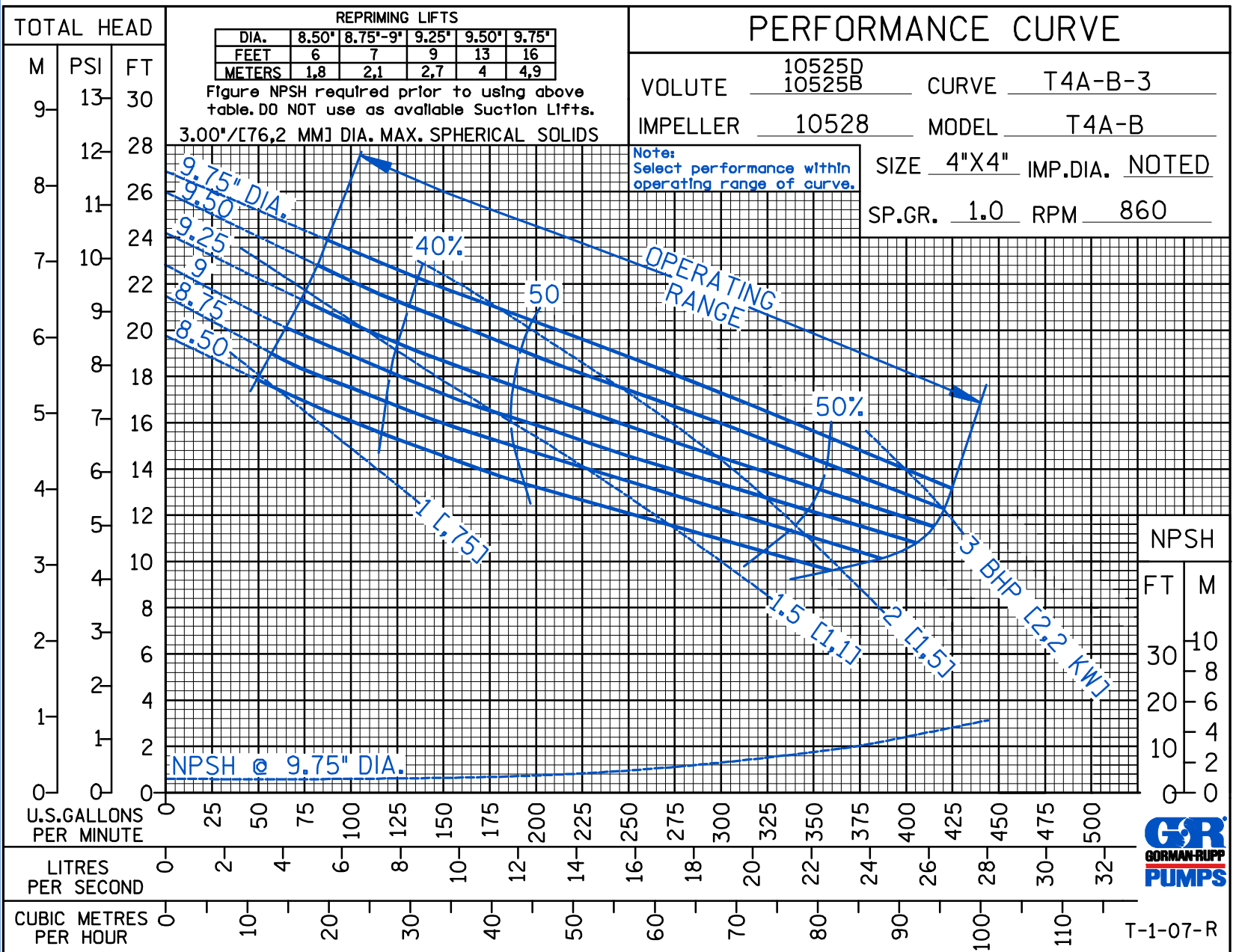

CDSW

Curve Data

Sec. 55

PAGE 2145.3
JULY 2008



THE GORMAN-RUPP COMPANY • MANSFIELD, OHIO
 GORMAN-RUPP OF CANADA LIMITED • ST. THOMAS, ONTARIO, CANADA
 www.grpumps.com
 Specifications Subject to Change Without Notice

© Copyright by the Gorman-Rupp Company 2008

Printed in U.S.A.

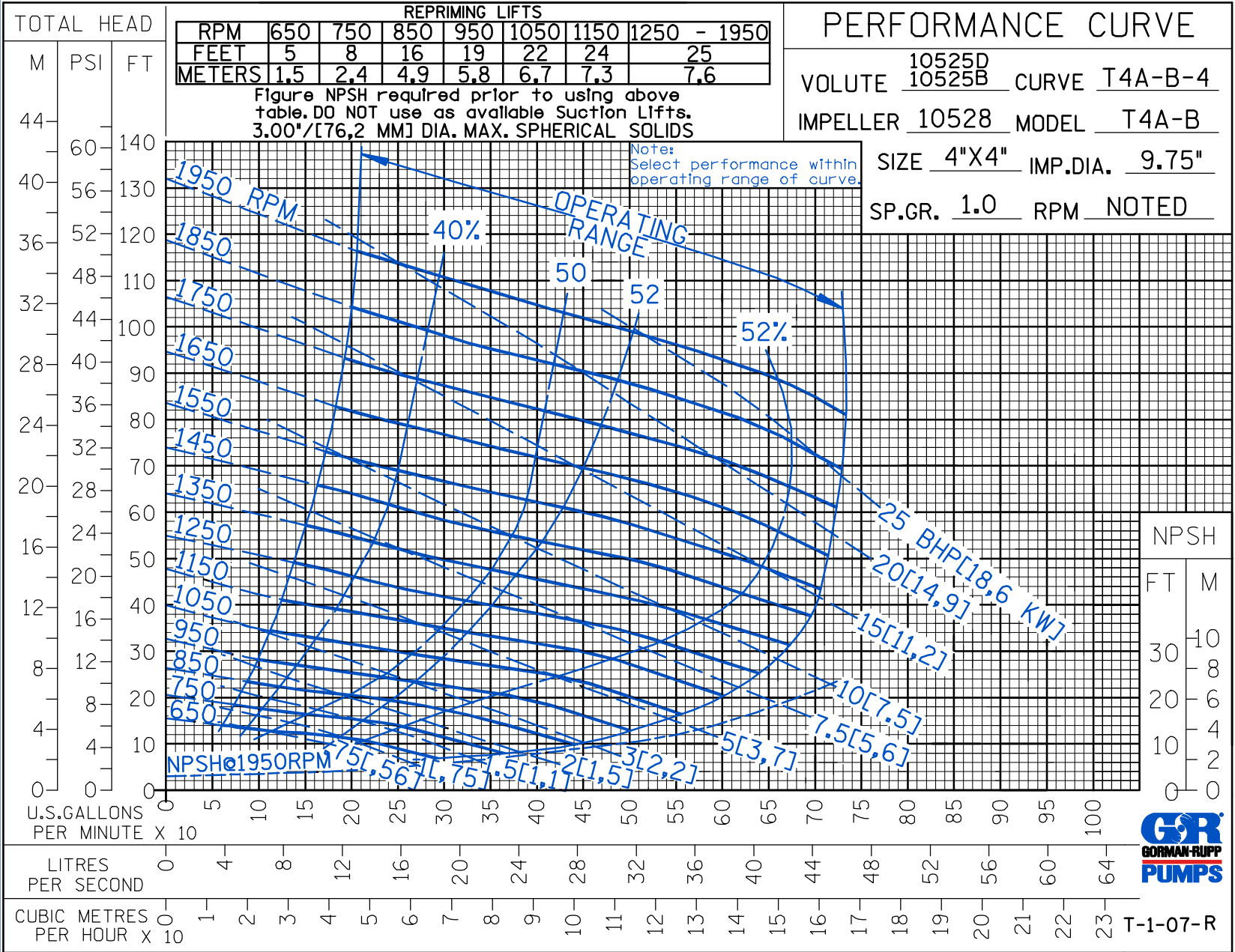

CDSW

Curve Data

Sec. 55

PAGE 2145.4
 JULY 2008



THE GORMAN-RUPP COMPANY • MANSFIELD, OHIO

GORMAN-RUPP OF CANADA LIMITED • ST. THOMAS, ONTARIO, CANADA

www.grpumps.com

Specifications Subject to Change Without Notice

Printed in U.S.A.

© Copyright by the Gorman-Rupp Company 2008

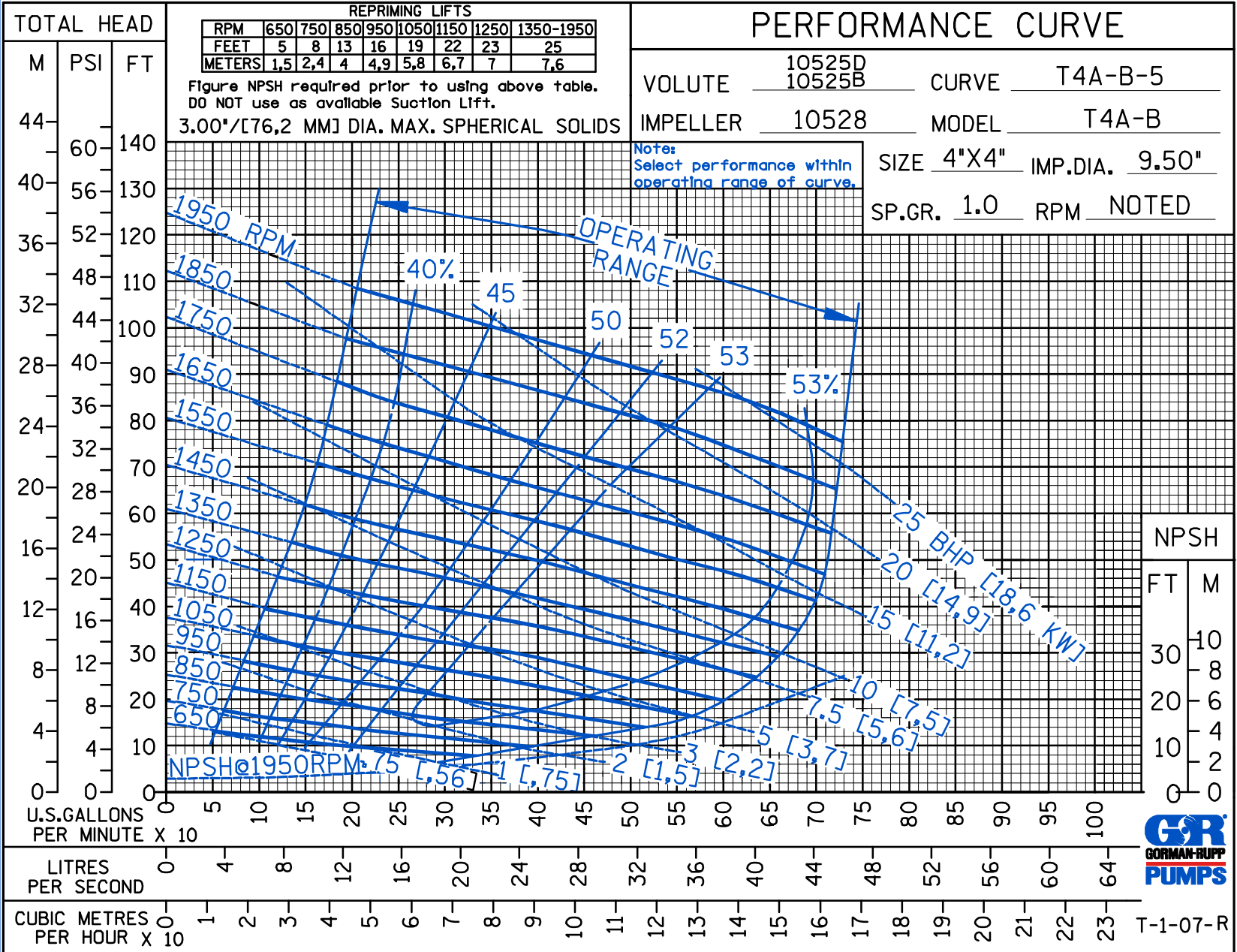

Curve Data

CDSW

Sec. 55
PAGE 2145.5
JULY 2008



T-1-07-R



THE GORMAN-RUPP COMPANY • MANSFIELD, OHIO
 GORMAN-RUPP OF CANADA LIMITED • ST. THOMAS, ONTARIO, CANADA
 www.grpumps.com

© Copyright by the Gorman-Rupp Company 2008

Specifications Subject to Change Without Notice

Printed in U.S.A.

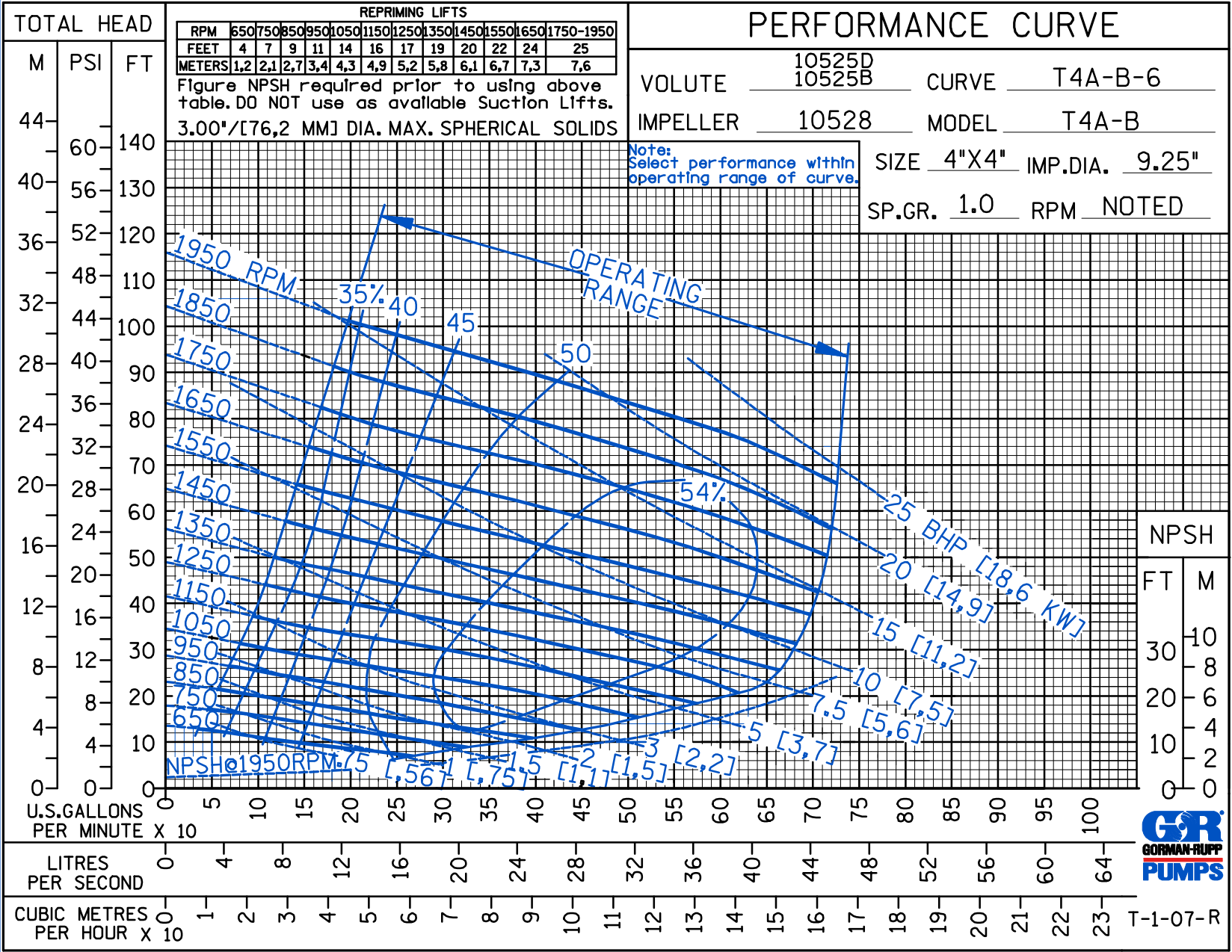

CDSW

Curve Data

Sec. 55

PAGE 2145.6
 JULY 2008



T-1-07-R



THE GORMAN-RUPP COMPANY • MANSFIELD, OHIO

GORMAN-RUPP OF CANADA LIMITED • ST. THOMAS, ONTARIO, CANADA

www.grpumps.com

Specifications Subject to Change Without Notice

Printed in U.S.A.

© Copyright by the Gorman-Rupp Company 2008

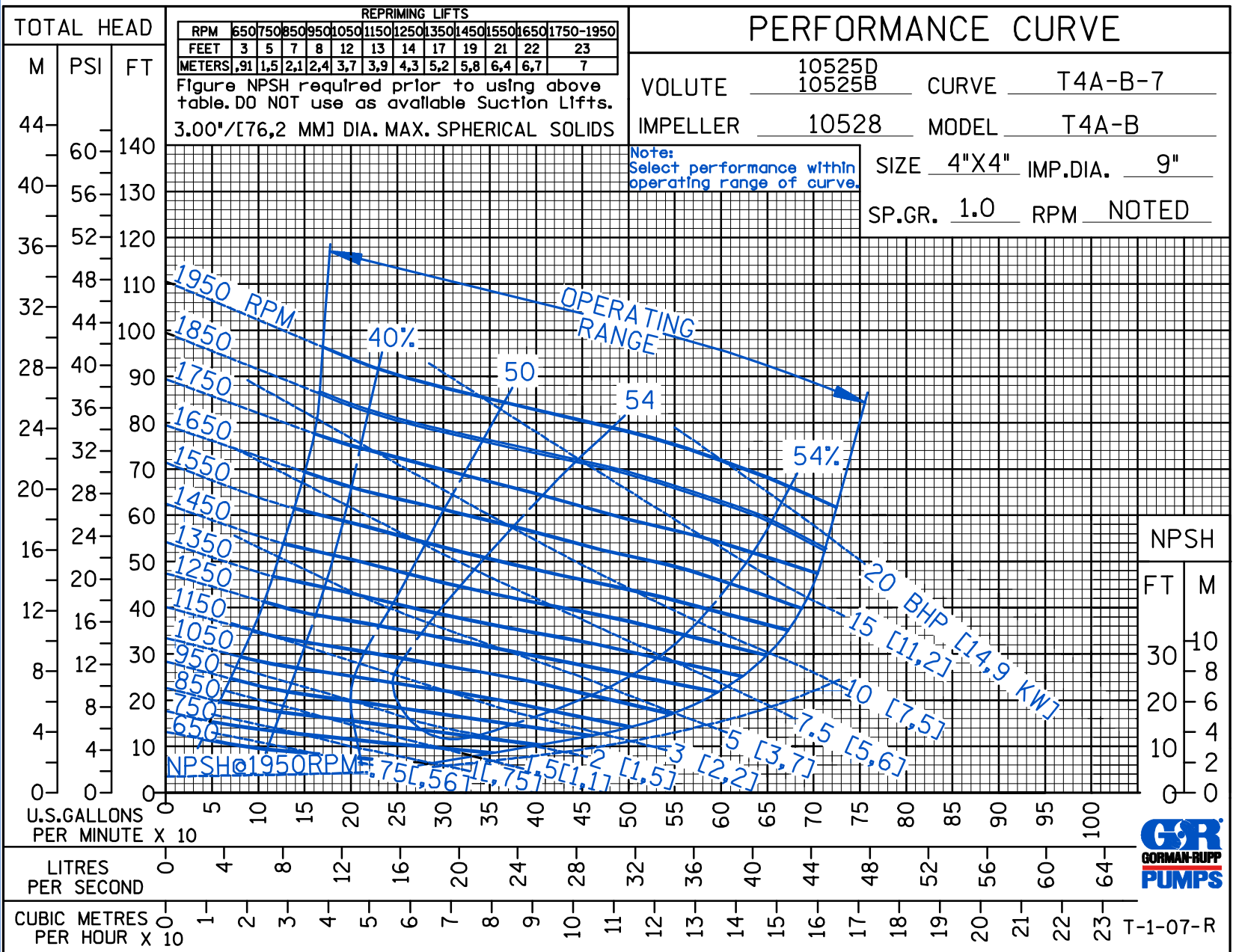

CDSW

Curve Data

Sec. 55

PAGE 2145.7
JULY 2008



T-1-07-R



THE GORMAN-RUPP COMPANY • MANSFIELD, OHIO
 GORMAN-RUPP OF CANADA LIMITED • ST. THOMAS, ONTARIO, CANADA
 www.grpumps.com

© Copyright by the Gorman-Rupp Company 2008

Specifications Subject to Change Without Notice

Printed in U.S.A.

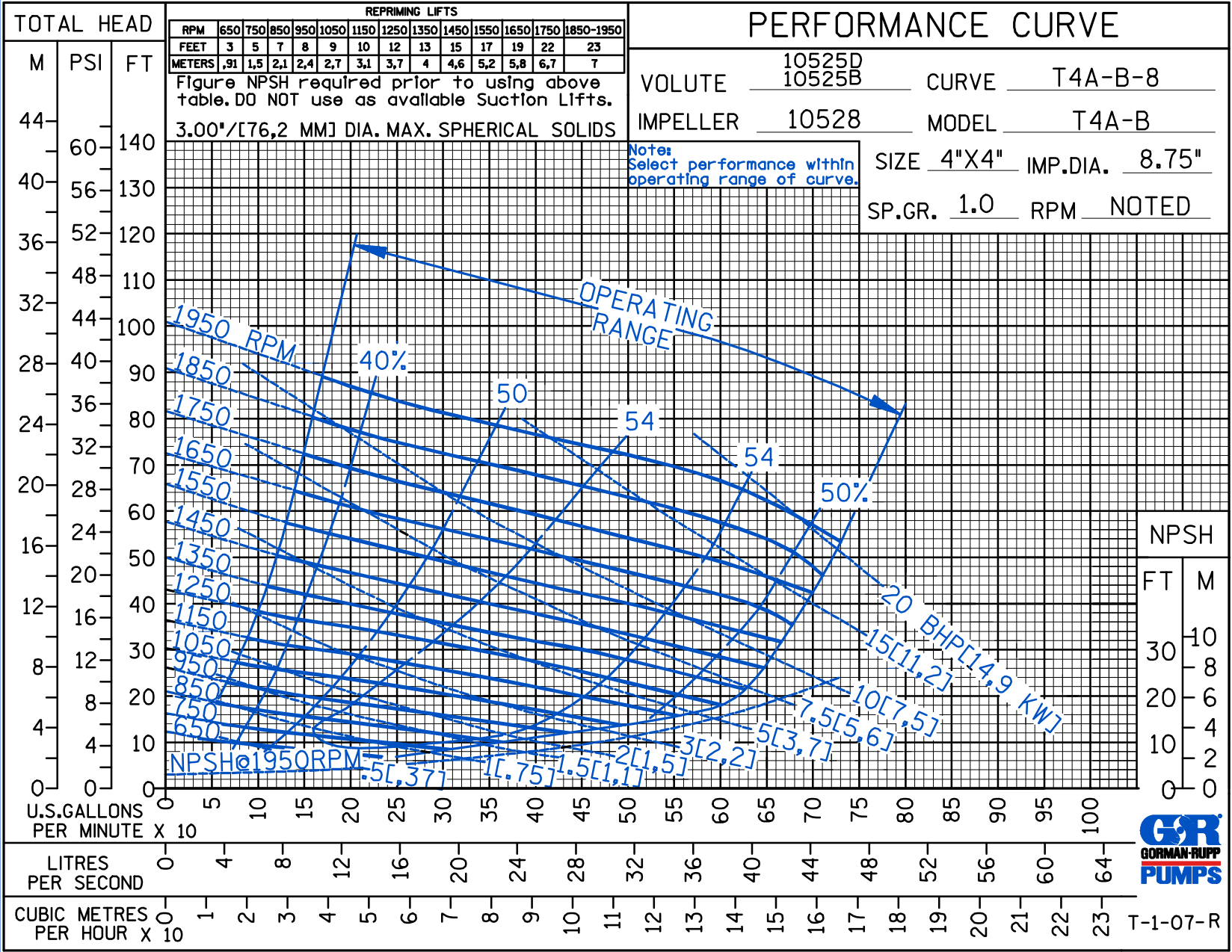

CDSW

Curve Data

Sec. 55

PAGE 2145.8
JULY 2008





THE GORMAN-RUPP COMPANY • MANSFIELD, OHIO

GORMAN-RUPP OF CANADA LIMITED • ST. THOMAS, ONTARIO, CANADA

www.grpumps.com

Specifications Subject to Change Without Notice

Printed in U.S.A.

© Copyright by the Gorman-Rupp Company 2008

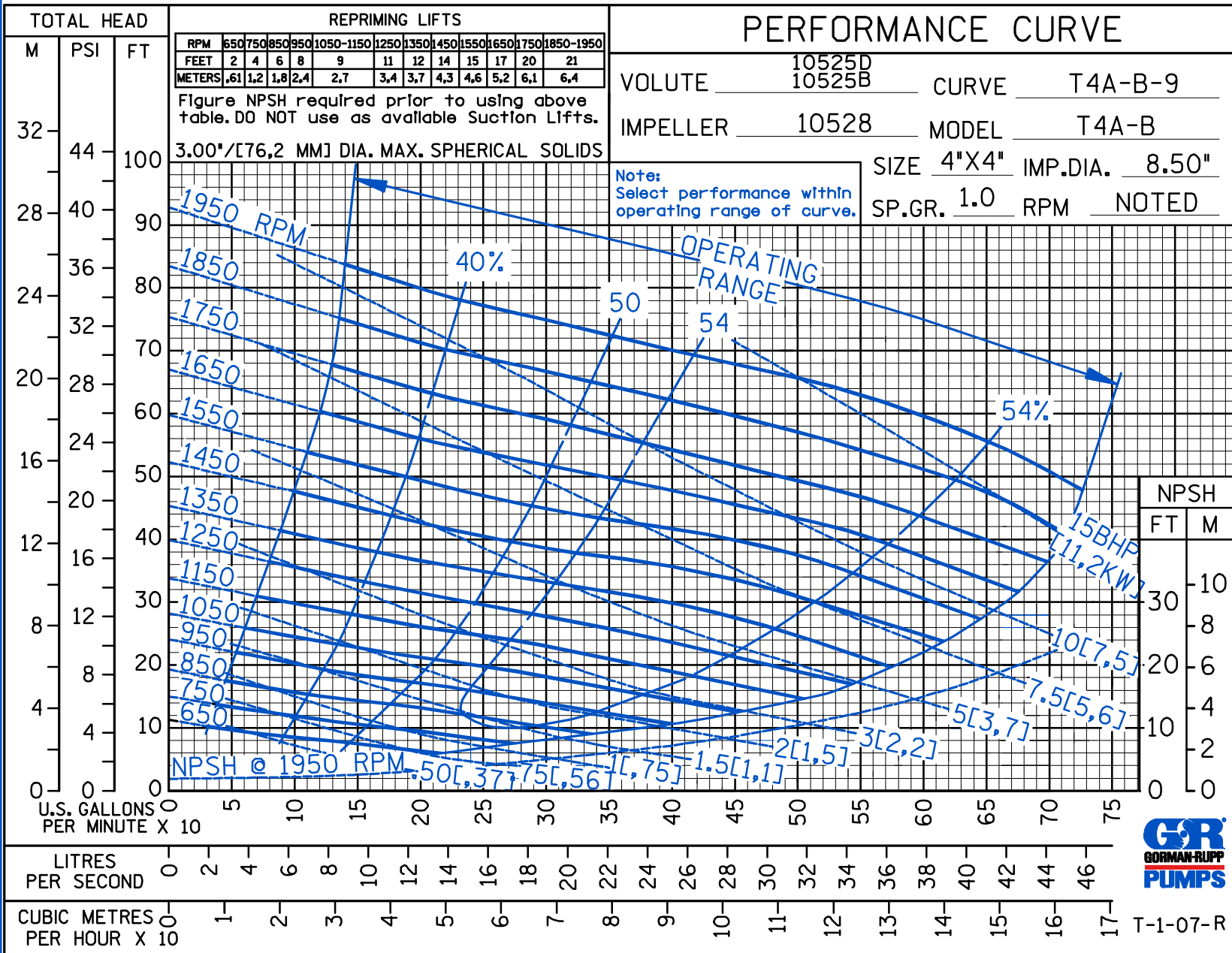

Curve Data

Sec. 55

PAGE 2145.9
JULY 2008

CDSW



THE GORMAN-RUPP COMPANY • MANSFIELD, OHIO
 GORMAN-RUPP OF CANADA LIMITED • ST. THOMAS, ONTARIO, CANADA
 www.grpumps.com

© Copyright by the Gorman-Rupp Company 2008

Specifications Subject to Change Without Notice

Printed in U.S.A.

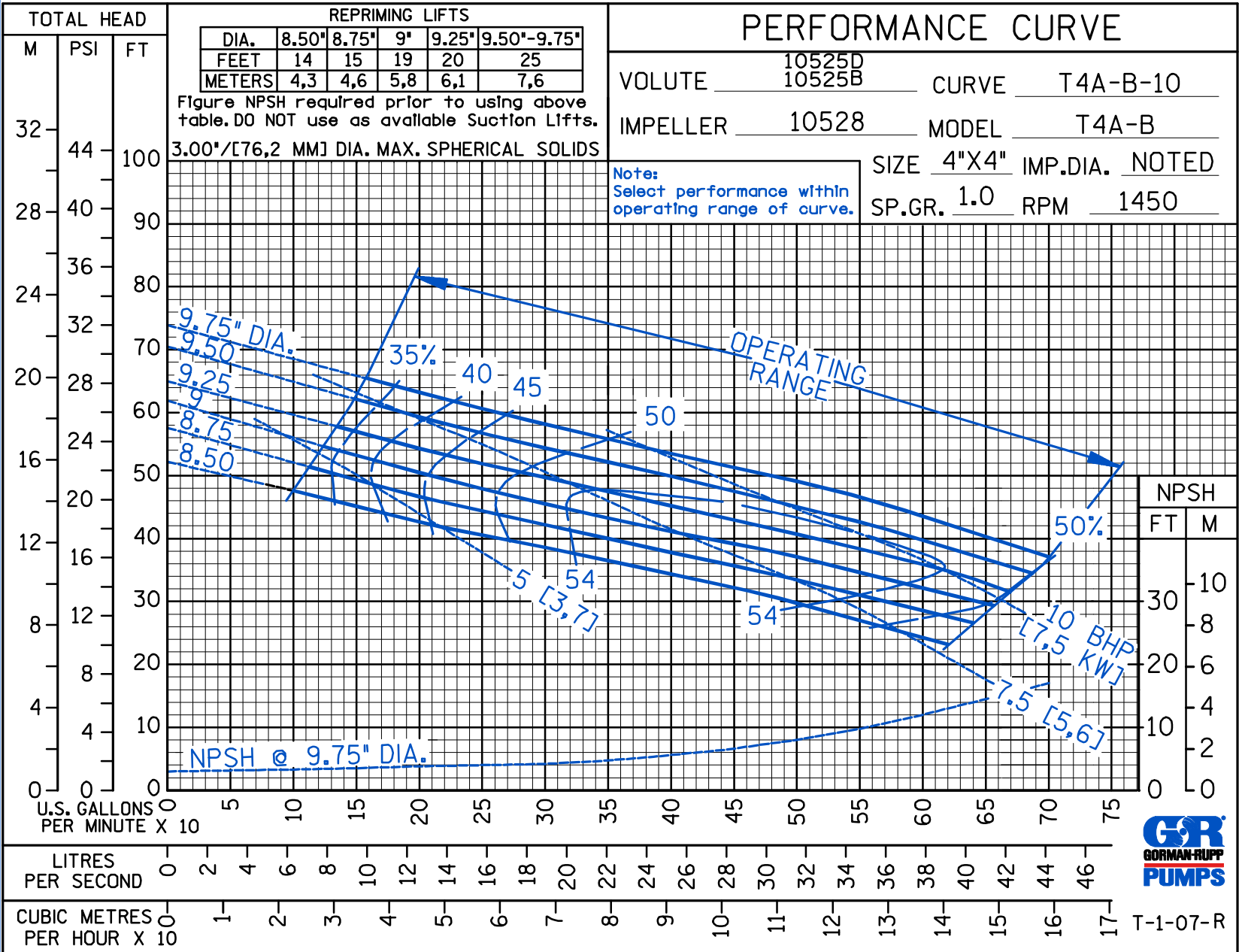

CDSW

Curve Data

Sec. 55

PAGE 2145.10
JULY 2008



THE GORMAN-RUPP COMPANY • MANSFIELD, OHIO

GORMAN-RUPP OF CANADA LIMITED • ST. THOMAS, ONTARIO, CANADA

www.grpmumps.com

Specifications Subject to Change Without Notice

Printed in U.S.A.

© Copyright by the Gorman-Rupp Company 2008

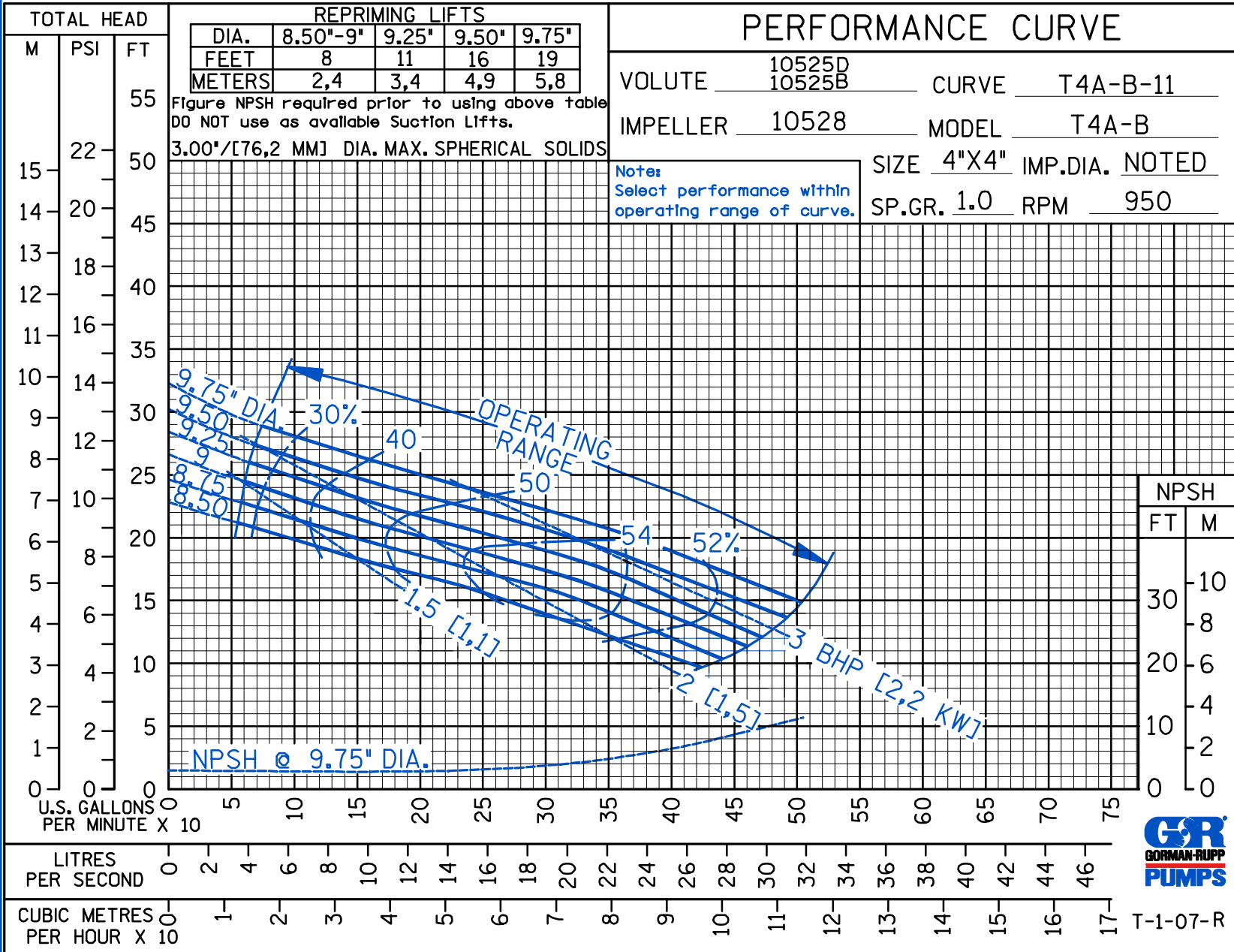

CDSW

Curve Data

Sec. 55

PAGE 2145.11
JULY 2008



D S W

PERFORMANCE CURVE

VOLUTE	10525D 10525B	CURVE	T4A-B-12
IMPELLER	10528	MODEL	T4A-B
		SIZE	4"X4" IMP.DIA. 9.75"
		SP.GR.	1.0 RPM NOTED

NOTE: See single pump curve for horsepower, efficiency, & NPSH

2 PUMPS IN PARALLEL

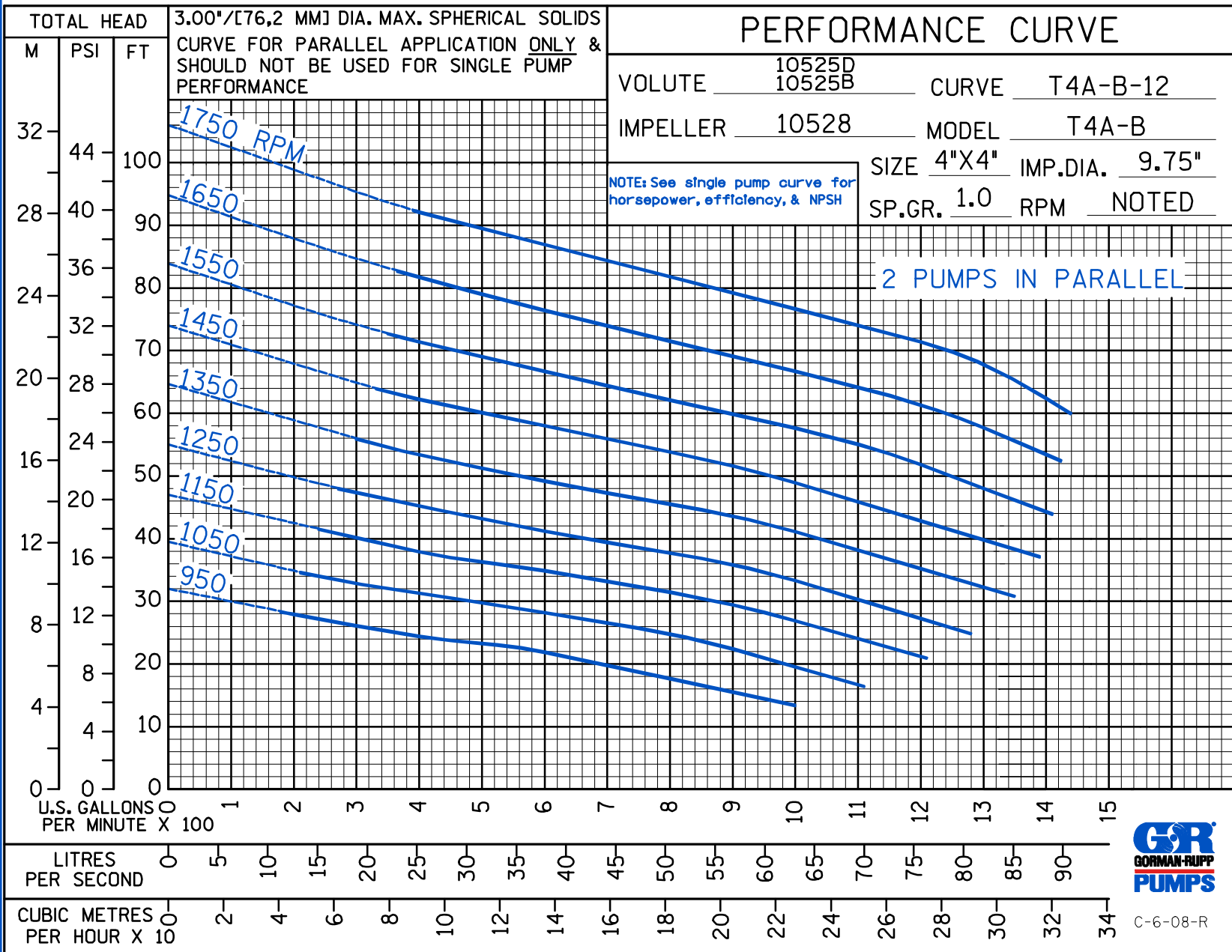

C-6-08-R



THE GORMAN-RUPP COMPANY • MANSFIELD, OHIO
GORMAN-RUPP OF CANADA LIMITED • ST. THOMAS, ONTARIO, CANADA

www.grpumps.com
Specifications Subject to Change Without Notice

Printed in U.S.A.



THE GORMAN-RUPP COMPANY • MANSFIELD, OHIO

GORMAN-RUPP OF CANADA LIMITED • ST. THOMAS, ONTARIO, CANADA

www.grpmumps.com

Specifications Subject to Change Without Notice

Printed in U.S.A.

© Copyright by the Gorman-Rupp Company 2008

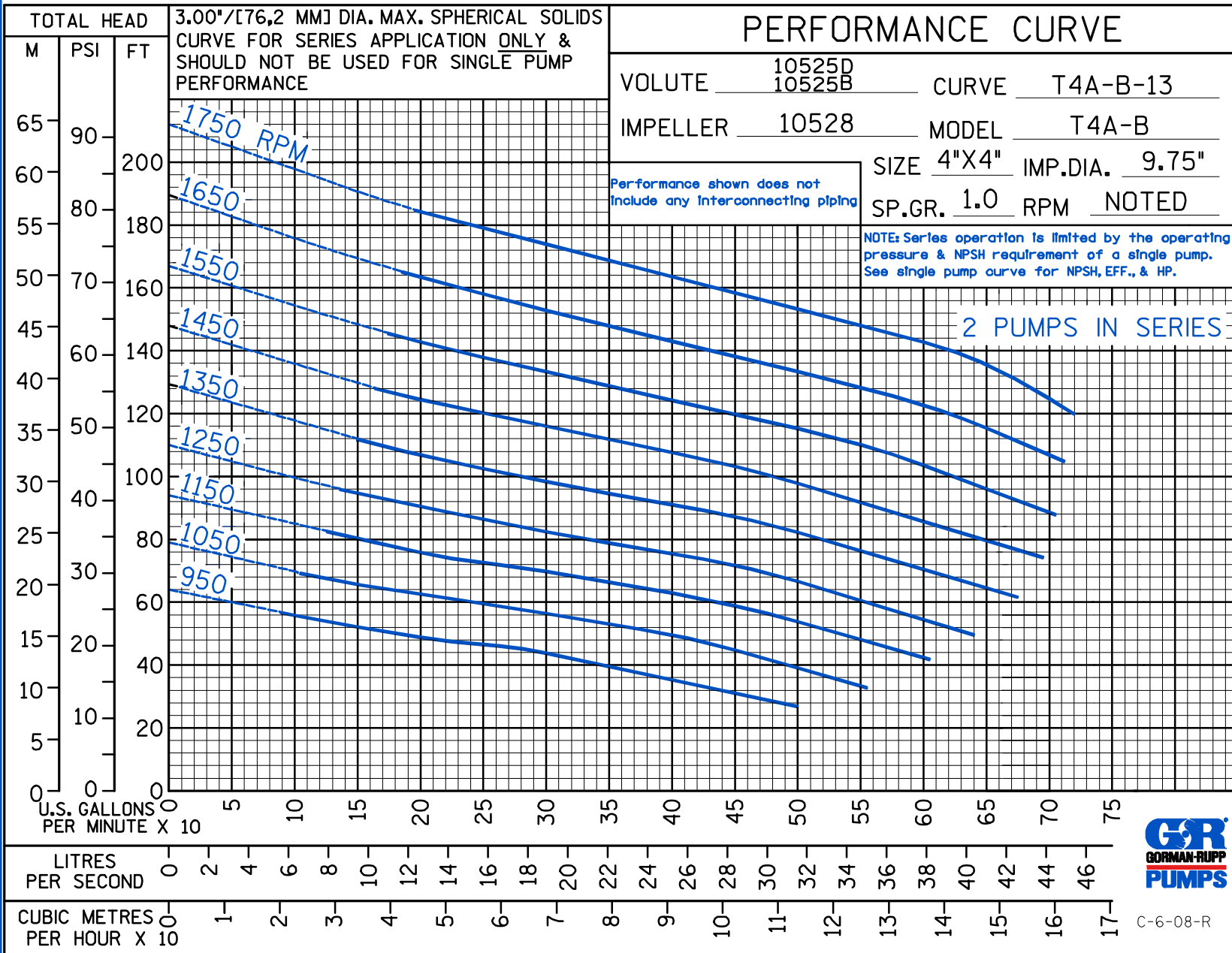

D S W

Curve Data

Sec. 55

PAGE 2145.13
JULY 2008



C-6-08-R