

CDS

Self Priming Centrifugal Pump

**Super
T SERIES**

VARIOUS PATENTS APPLY

Model T8A61S-B**Size 8" x 8"****PUMP SPECIFICATIONS****Size:** 8" (203 mm) ASA Flanged Suction x 8" (203 mm) NPT Female Discharge.**Casing:** Gray Iron 30.

Maximum Operating Pressure 83 psi (572 kPa).*

Semi-Open Type, Two Vane Impeller: Stainless Steel 316.

Handles 3" (76,2 mm) Diameter Spherical Solids.

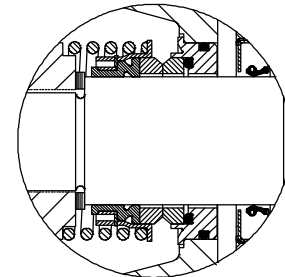
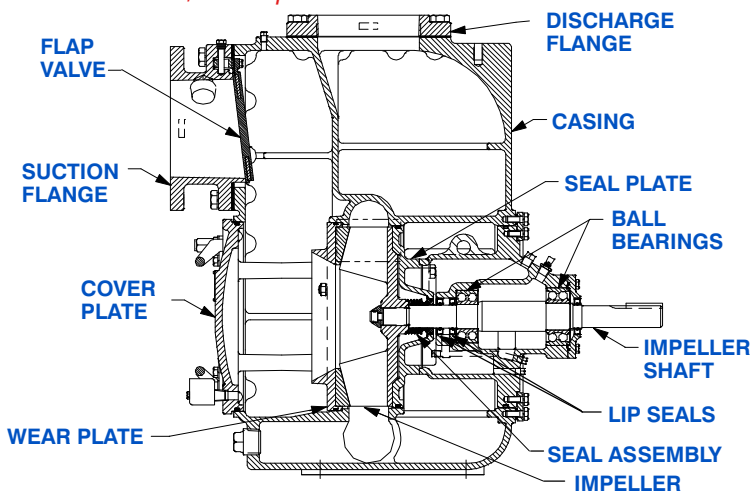
Impeller Shaft: Stainless Steel 17-4 PH.**Replaceable Wear Plate:** Stainless Steel 316.**Removable Adjustable Cover Plate:** Gray Iron 30; 94 lbs. (43 kg).**Flap Valve:** Neoprene w/Nylon and Steel Reinforcing.**Seal Plate:** Stainless Steel 316.**Bearing Housing:** Gray Iron 30.**Radial and Thrust Bearings:** Open Double Row Ball.**Bearing and Seal Cavity Lubrication:** SAE 30 Non-Detergent Oil.**Flanges:** Gray Iron 30.**Gaskets:** Buna-N, Compressed Synthetic Fibers, PTFE, Cork, and Rubber.**O-Rings:** Buna-N.**Internal Wetted Hardware:** Stainless Steel 316.**External Hardware:** Standard Plated Steel.**Pressure Relief Valve:** Stainless Steel 316.**Bearing and Seal Cavity Oil Level Sight Gauges.****Optional Equipment:** Metal Bellows Seal. Automatic Air Release Valve. Stainless Steel CD4MCu Impeller, Seal Plate and Wear Plate. 120V/240V Casing Heater. High Pump Temperature Shutdown Kit. Self-Cleaning Wear Plate. Gray Iron 30 Spool Flanges:8" ASA Discharge (**Specify Model T8A61S-B /F**).200 mm DIN 2527 (PN 16) Suction and Discharge (**Specify Model T8A61S-B /FM**).**Consult Factory for Applications Exceeding Maximum Pressure and/or Temperature Indicated.***Shown with Optional Discharge Spool Flange (Available in ASA or DIN Standard Sizes).****SEAL DETAIL**

Mechanical, Oil-Lubricated, Double Floating, Self-Aligning. Silicon Carbide Rotating and Stationary Faces. Stainless Steel 316 Stationary Seat. Fluorocarbon Elastomers (DuPont Viton® or Equivalent). Stainless Steel 18-8 Cage and Spring. Maximum Temperature of Liquid Pumped, 160°F (71°C).*

**THE GORMAN-RUPP COMPANY • MANSFIELD, OHIO**

GORMAN-RUPP OF CANADA LIMITED • ST. THOMAS, ONTARIO, CANADA

www.grpumps.com

Specifications Subject to Change Without Notice

Printed in U.S.A.

CDS

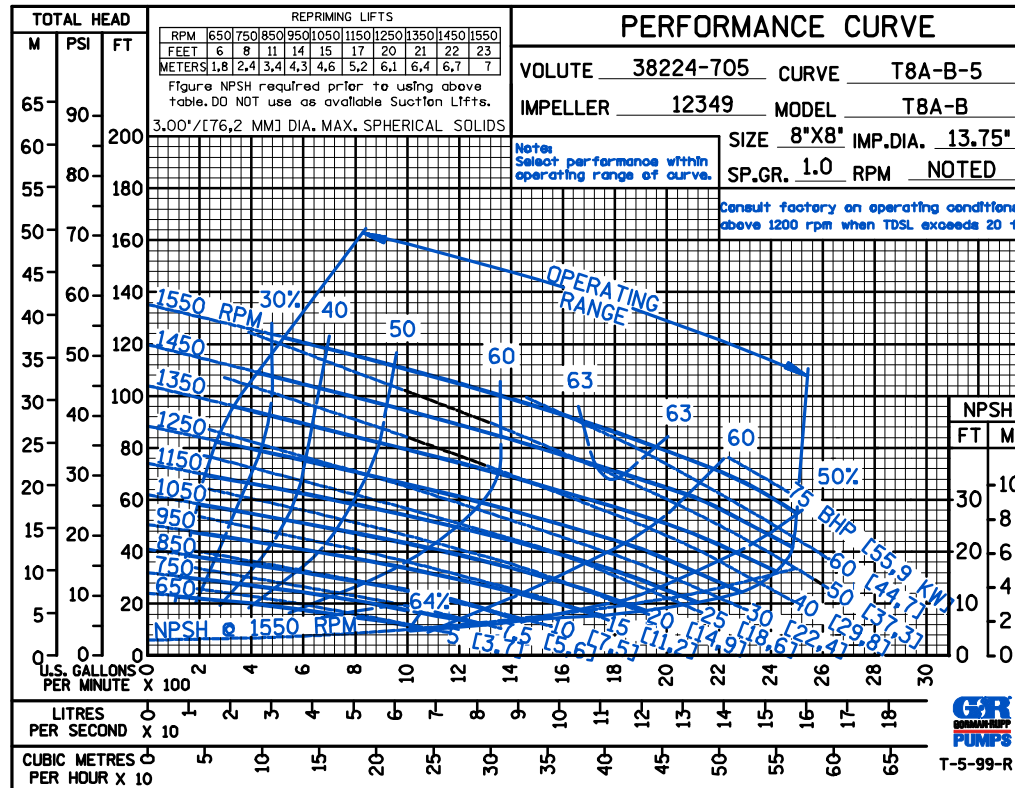
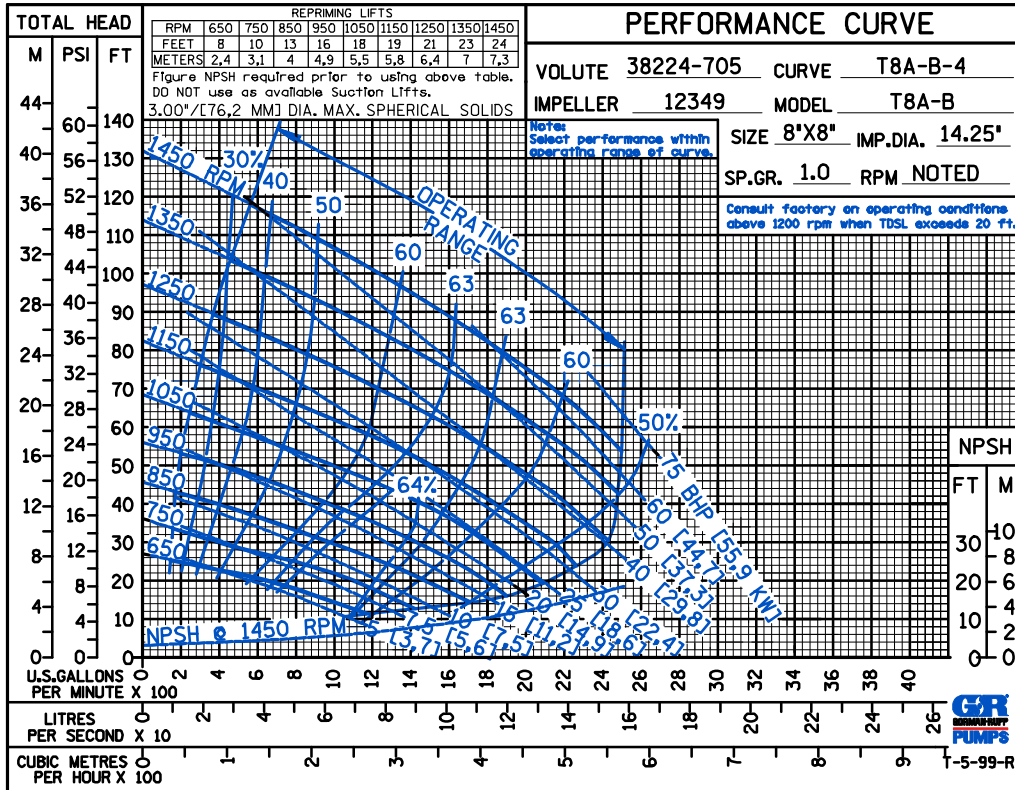

THE GORMAN-RUPP COMPANY • MANSFIELD, OHIO

GORMAN-RUPP OF CANADA LIMITED • ST. THOMAS, ONTARIO, CANADA

Specifications Subject to Change Without Notice

Printed in U.S.A.

CDS

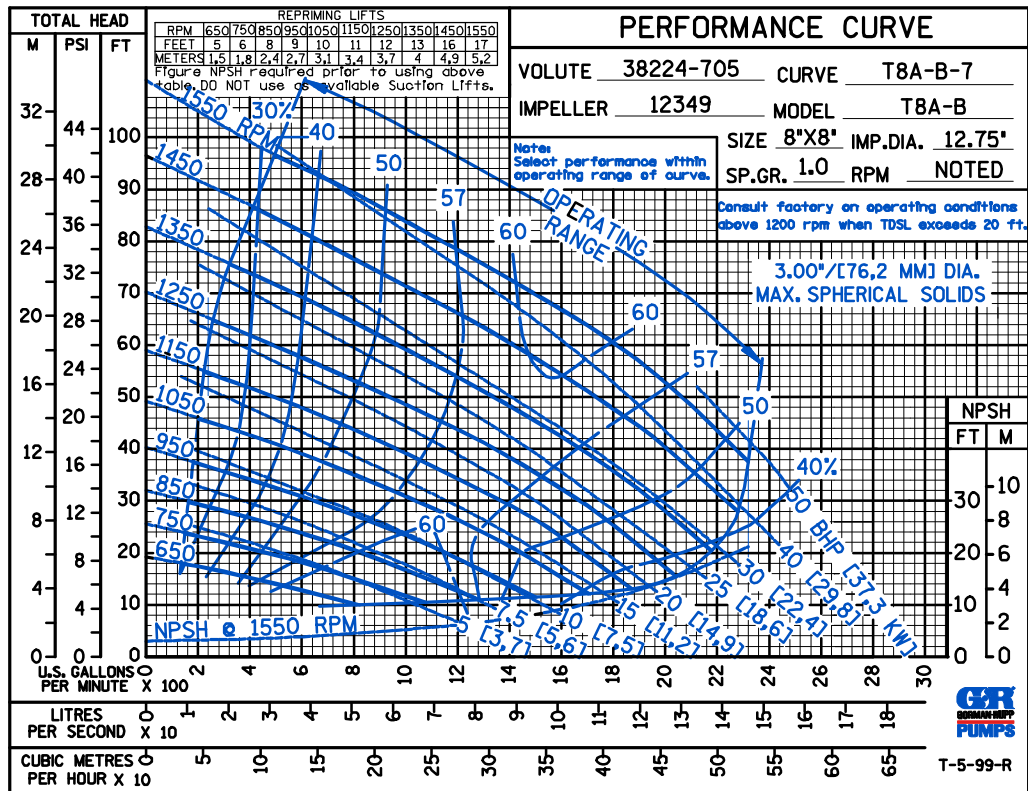
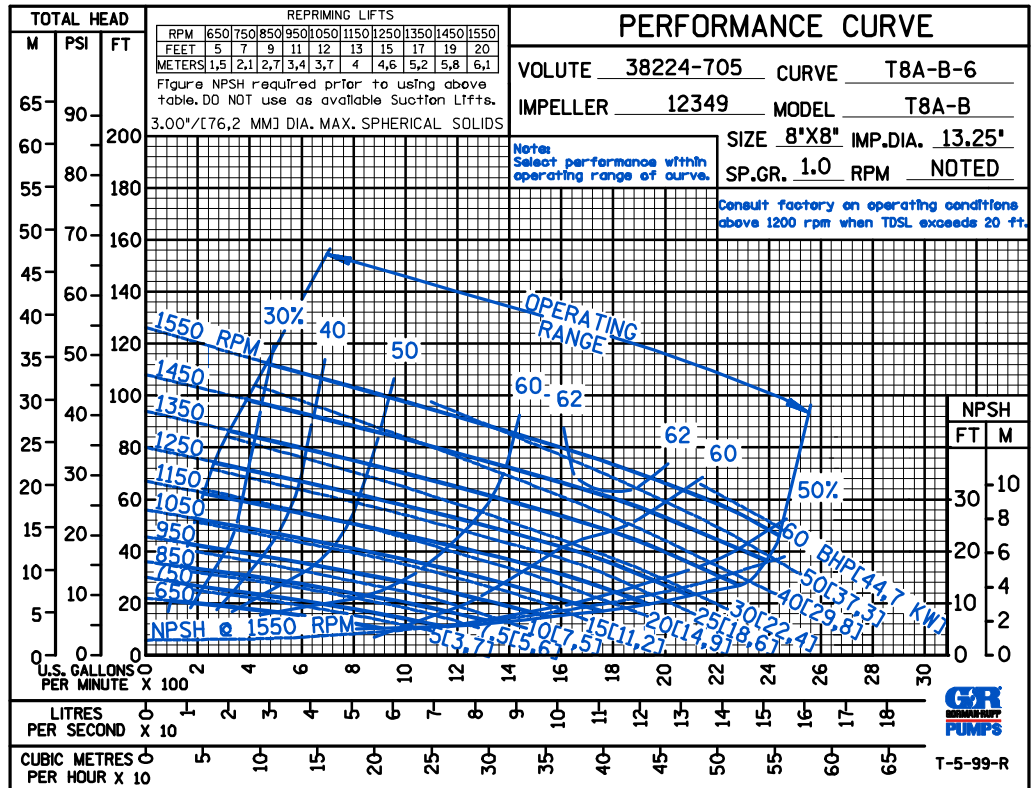

THE GORMAN-RUPP COMPANY • MANSFIELD, OHIO

GORMAN-RUPP OF CANADA LIMITED • ST. THOMAS, ONTARIO, CANADA

Specifications Subject to Change Without Notice

Printed in U.S.A.

CDS

50 HERTZ

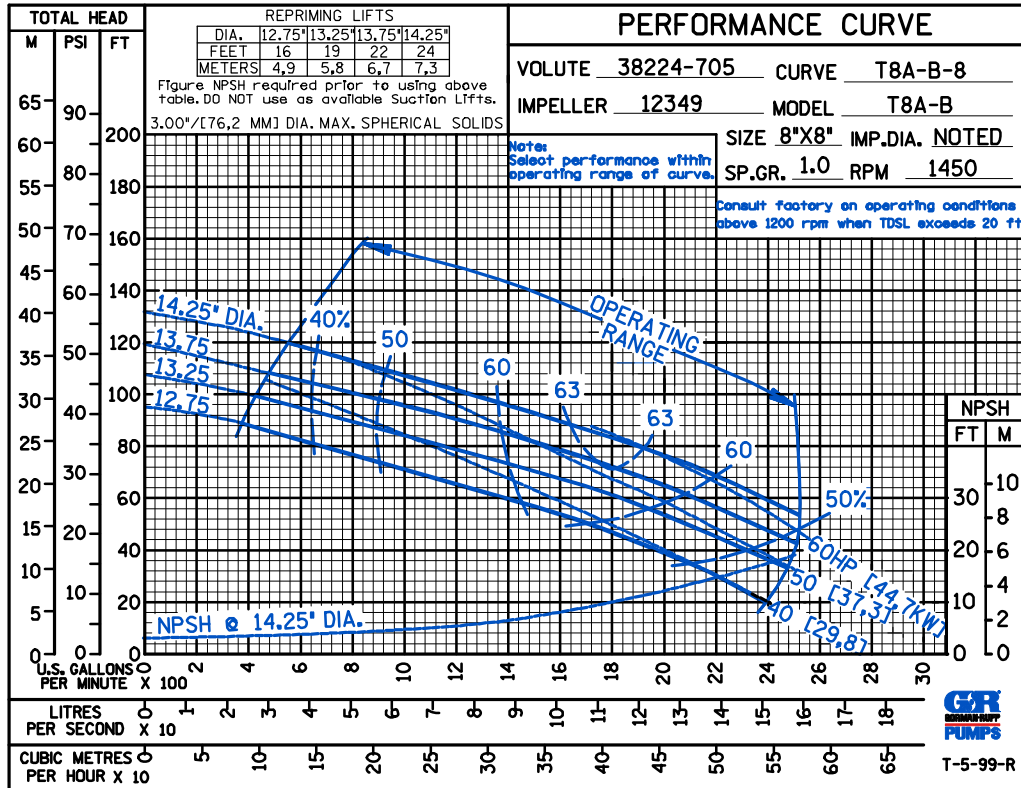

50 HERTZ

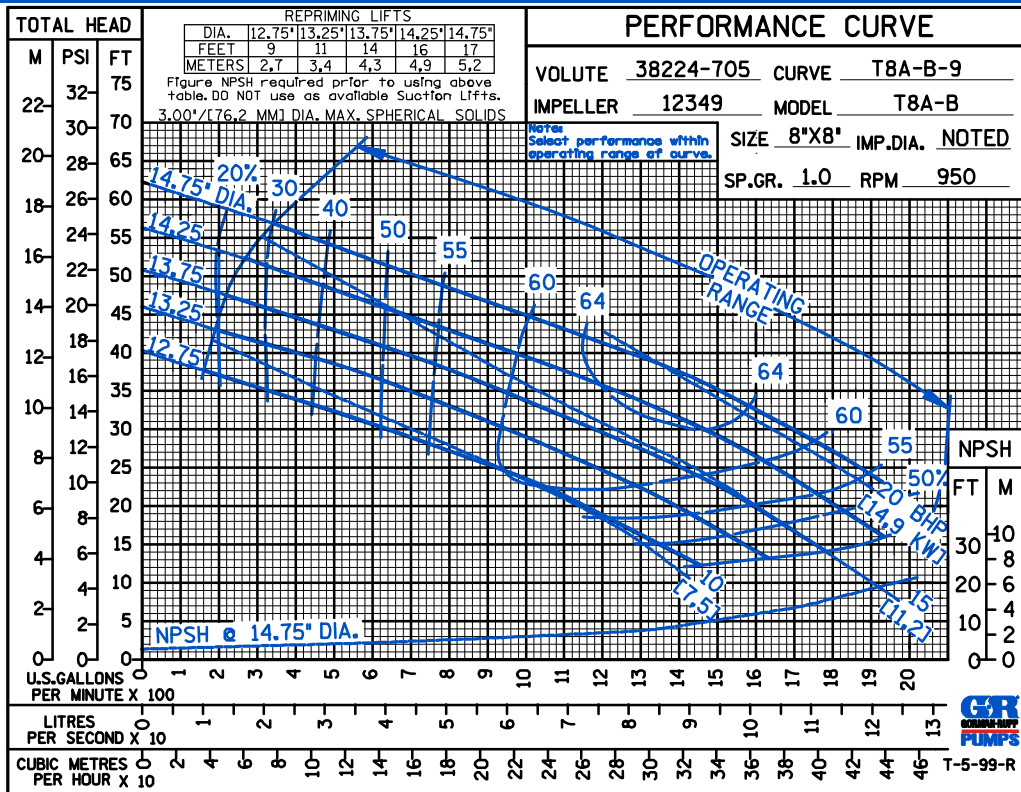

THE GORMAN-RUPP COMPANY • MANSFIELD, OHIO

GORMAN-RUPP OF CANADA LIMITED • ST. THOMAS, ONTARIO, CANADA

Specifications Subject to Change Without Notice

Printed in U.S.A.

CDS

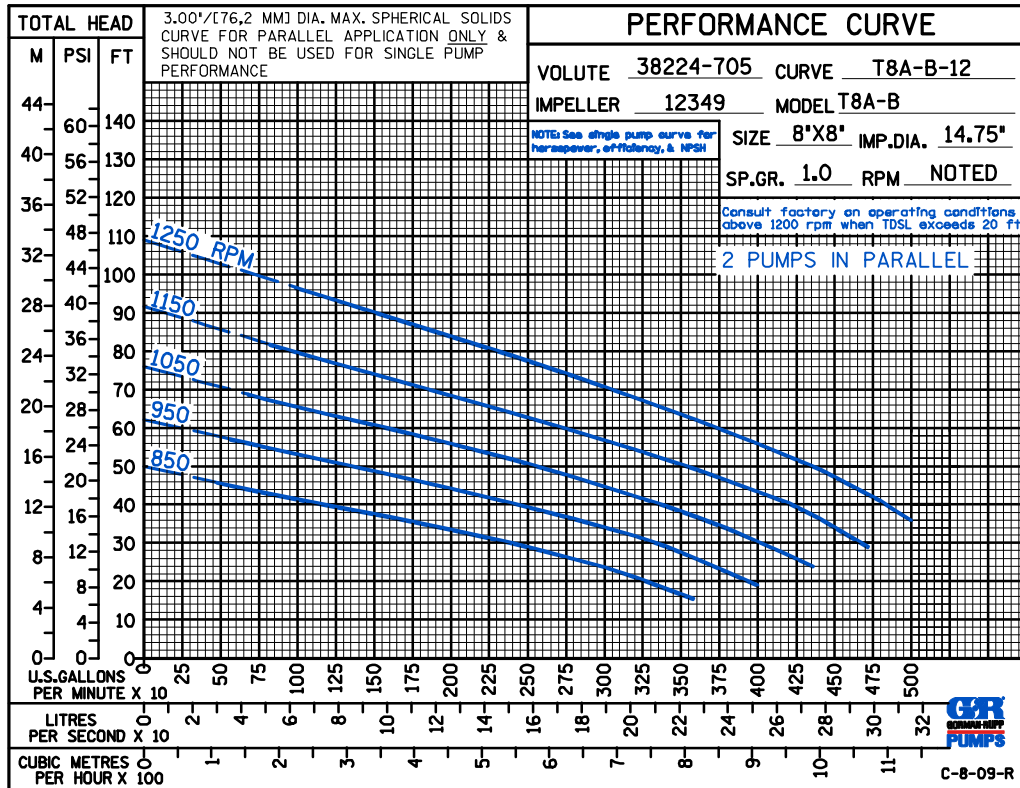
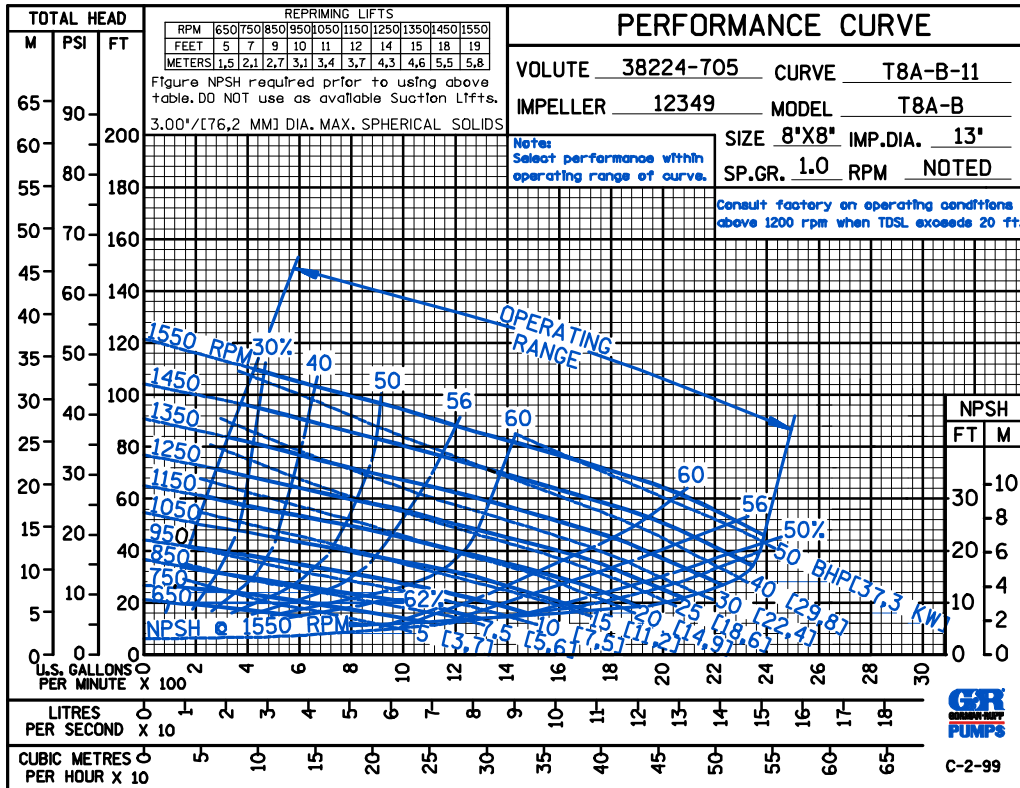

THE GORMAN-RUPP COMPANY • MANSFIELD, OHIO

GORMAN-RUPP OF CANADA LIMITED • ST. THOMAS, ONTARIO, CANADA

Specifications Subject to Change Without Notice

Printed in U.S.A.

