

Super
T SERIES

VARIOUS PATENTS APPLY

Equipped With
ERADICATOR
Solids Management System

Self Priming Centrifugal Pump

Model T6C71SC-B

Size 6" x 6"



PUMP SPECIFICATIONS

Size: 6" x 6" (152 mm x 152 mm) NPT - Female.

Casing: Gray Iron 30.

Maximum Operating Pressure 78 psi (538 kPa).*

Semi-Open Type, Two Vane Impeller: G-R Hard Iron.

Handles 3" (76,2 mm) Diameter Spherical Solids.

Impeller Shaft: Alloy Steel 4150.

Shaft Sleeve: Alloy Steel 4130.

Replaceable Self-Cleaning Wear Plate: Hardened Alloy Steel.

Adjustable Back Cover Plate: Gray Iron 30.

Removable Inspection Cover Plate: Gray Iron 30; 20 lbs. (9,1 kg.).

Flap Valve: Neoprene ^W/Nylon and Steel Reinforcing.

Seal Plate: G-R Hard Iron.

Bearing Housing: Gray Iron 30.

Radial Bearing: Open Single Row Ball.

Thrust Bearing: Open Double Row Ball.

Bearing and Seal Cavity Lubrication: SAE 30 Non-Detergent Oil.

Flanges: Gray Iron 30.

Gaskets: Buna-N, Compressed Synthetic Fibers, Vegetable Fiber, PTFE, Cork, and Rubber.

O-Rings: Buna-N.

Hardware: Standard Plated Steel.

Brass Pressure Relief Valve.

Bearing and Seal Cavity Oil Level Sight Gauges.

Optional Equipment: Tungsten Titanium Carbide Seal. Metal Bellows Seal. Automatic Air Release Valve. 120V/240V Casing Heater. High Pump Temperature Shutdown Kit. G-R Hard Iron Casing. High Chrome Cast Iron Impeller.

Gray Iron 30 Suction and Discharge Spool Flanges:

6" ASA (**Specify Model T6C71SC-B /F**).

150 mm DIN 2527 (PN 16) (**Specify Model T6C71SC-B /FM**).

**Consult Factory for Applications Exceeding Maximum Pressure and/or Temperature Indicated.*

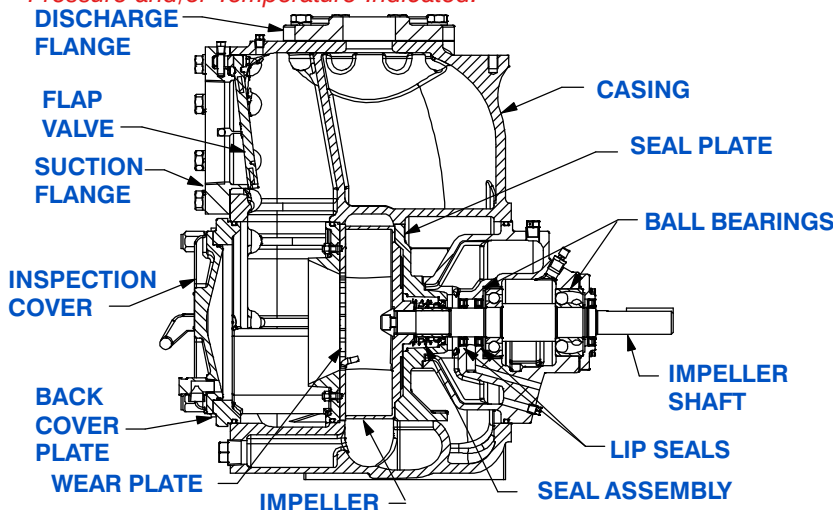

Shown with Optional Suction and Discharge Spool Flanges (Available in ASA or DIN Standard Sizes).

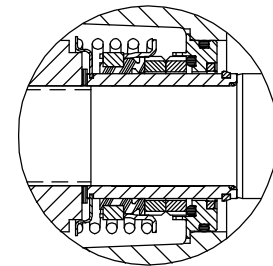

SEAL DETAIL

Cartridge Type, Mechanical, Oil-Lubricated, Double Floating, Self-Aligning. Silicon Carbide Rotating and Stationary Faces. Stainless Steel 316 Stationary Seat. Fluorocarbon Elastomers (DuPont Viton[®] or Equivalent). Stainless Steel 18-8 Cage and Spring. Maximum Temperature of Liquid Pumped, 160°F (71°C).*

GR
GORMAN-RUPP
PUMPS

GORMAN-RUPP PUMPS

www.grpumps.com

Specifications Subject to Change Without Notice

Printed in U.S.A.

Specification Data

SECTION 55, PAGE 2290

APPROXIMATE DIMENSIONS and WEIGHTS

NET WEIGHT: 880 LBS. (408 KG.)*
SHIPPING WEIGHT: 960 LBS. (302 KG.)*
EXPORT CRATE: 32.5 CU. FT. (0,92 CU. M.)
***ADD 25 LBS. (11,3 KG.) W/EACH SPOOL FLANGE**

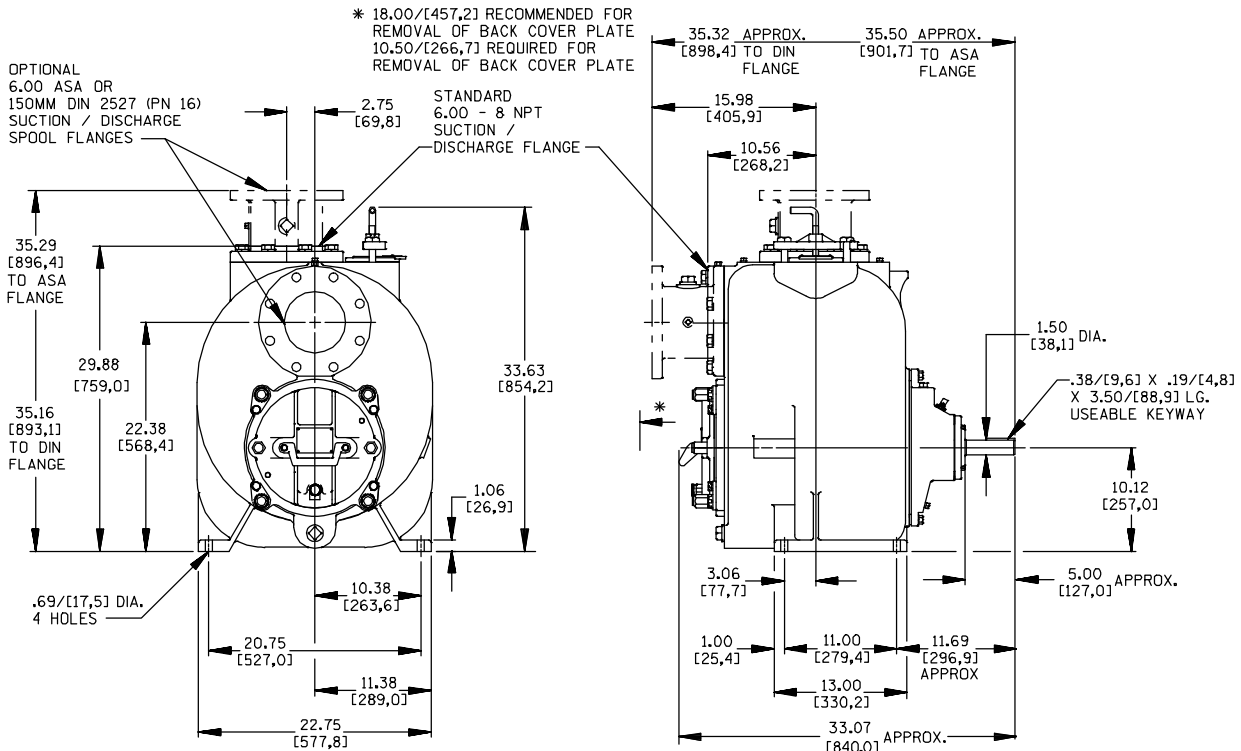

OPTIONAL ASA OR DIN STANDARD SUCTION & DISCHARGE SPOOL FLANGES AVAILABLE

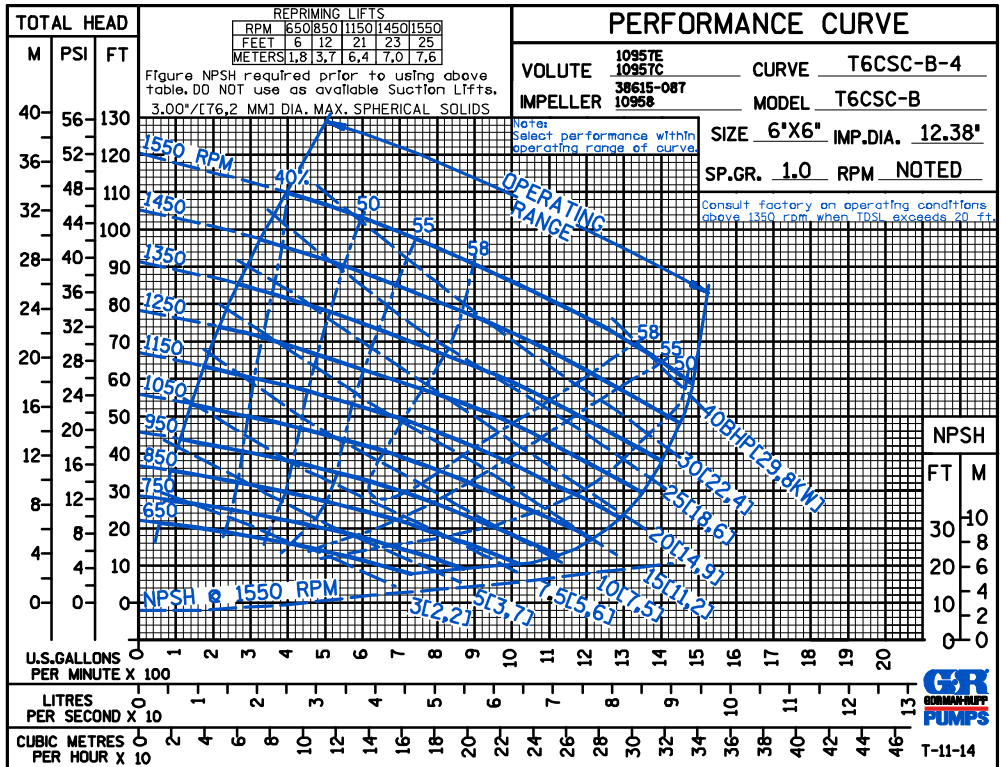

GORMAN-RUPP PUMPS

www.grpumps.com

Specifications Subject to Change Without Notice

Printed in U.S.A.