

CDS

# Self Priming Centrifugal Pump

**Super  
T SERIES**  
VARIOUS PATENTS APPLY

## Model T3A75S-B

### Size 3" x 3"



#### PUMP SPECIFICATIONS

**Size:** 3" x 3" (76 mm x 76 mm) NPT - Female.

**Casing:** G-R Hard Iron.

Maximum Operating Pressure 86 psi (593 kPa).\*

**Semi-Open Type, Two Vane Impeller:** G-R Hard Iron.

Handles 2 1/2" (63,5 mm) Diameter Spherical Solids.

**Impeller Shaft:** Alloy Steel 4150.

**Shaft Sleeve:** Alloy Steel 4130.

**Replaceable Wear Plate:** Hardened Alloy Steel.

**Removable Adjustable Cover Plate:** Gray Iron 30; 35 lbs. (16 kg)

**Flap Valve:** Neoprene <sup>w</sup>/Nylon and Steel Reinforcing.

**Seal Plate:** G-R Hard Iron.

**Bearing Housing:** Gray Iron 30.

**Radial/Thrust Bearings:** Open Single Row Ball.

**Bearing and Seal Cavity Lubrication:** SAE 30 Non-Detergent Oil.

**Flanges:** Gray Iron 30.

**Gaskets:** Buna-N, Compressed Synthetic Fibers, Vegetable Fiber, PTFE, Cork and Rubber.

**O-Rings:** Buna-N.

**Hardware:** Standard Plated Steel.

**Brass Pressure Relief Valve.**

**Bearing and Seal Cavity Oil Level Sight Gauges.**

**Optional Equipment:** Automatic Air Release Valve.

Metal Bellows Seal. 120V/240V Casing Heater. High Pump Temperature Shutdown Kit. Self-Cleaning Wear Plate.

High Chrome Cast Iron Impeller.

Gray Iron 30 Suction and Discharge Spool Flanges:

3" ASA (**Specify Model T3A75S-B /F**).

80 mm DIN 2527 (PN 16) (**Specify Model T3A75S-B /FM**).

*\*Consult Factory for Applications Exceeding Maximum Pressure and/or Temperature Indicated.*



Shown with Optional Suction & Discharge Spool Flanges (Available in ASA or DIN Standard Sizes).

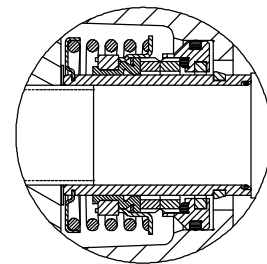
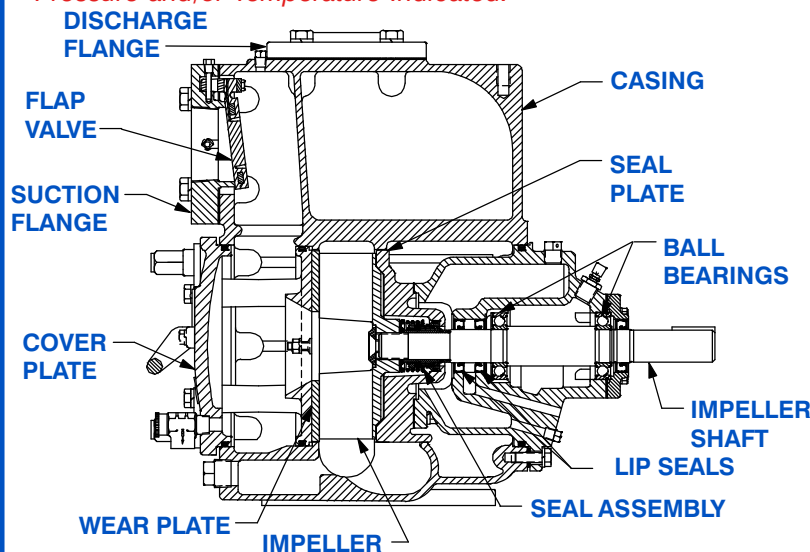

#### SEAL DETAIL

Cartridge Type, Mechanical, Oil-Lubricated, Double Floating, Self-Aligning. Silicon Carbide Rotating and Stationary Faces. Stainless Steel 316 Stationary Seat. Fluorocarbon Elastomers (DuPont Viton<sup>®</sup> or Equivalent). Stainless Steel 18-8 Cage and Spring. Maximum Temperature of Liquid Pumped, 160°F (71°C).\*



THE GORMAN-RUPP COMPANY • MANSFIELD, OHIO

GORMAN-RUPP OF CANADA LIMITED • ST. THOMAS, ONTARIO, CANADA

www.grpumps.com

Specifications Subject to Change Without Notice

Printed in U.S.A.

**Specification Data**

SECTION 55, PAGE 2042

**APPROXIMATE DIMENSIONS and WEIGHTS**

**NET WEIGHT: 414 LBS. (188 KG.)\***  
**SHIPPING WEIGHT: 462 LBS. (210 KG.)\***  
**EXPORT CRATE: 19.3 CU. FT. (0,55 CU. M.)**  
**\*ADD 10 LBS. (4,5 KG.) W/EACH SPOOL FLANGE**

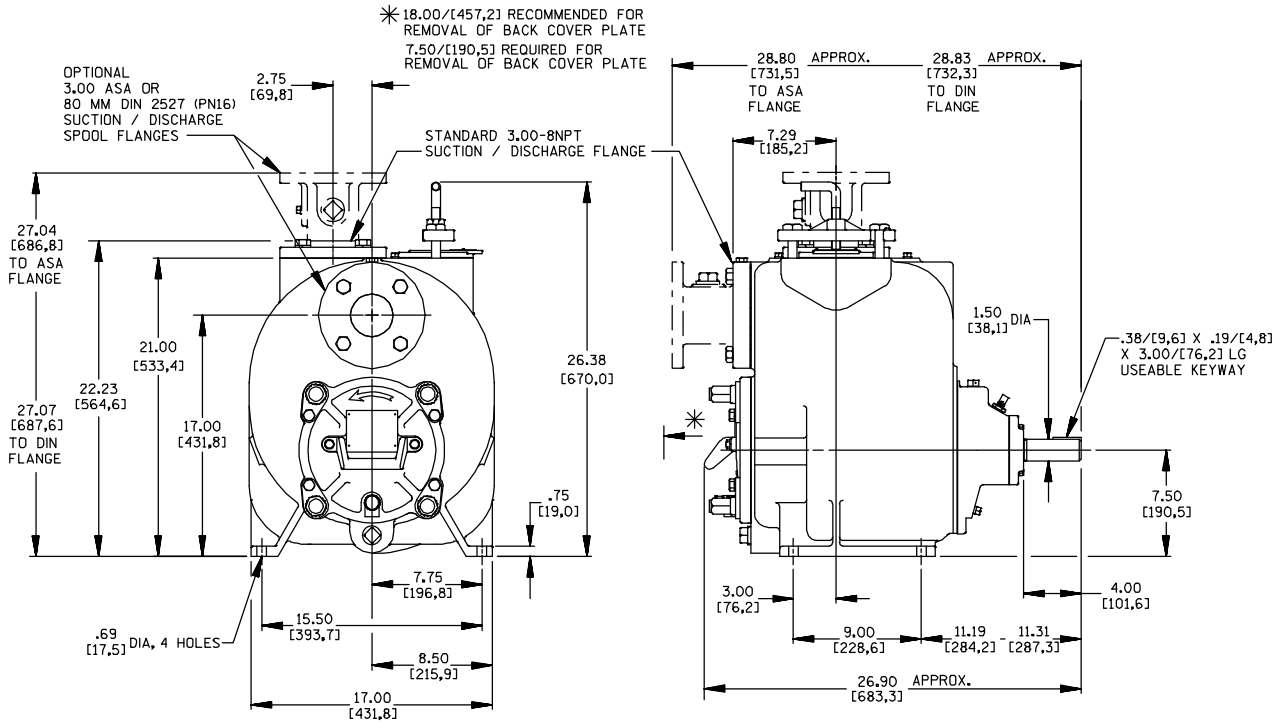

**OPTIONAL ASA OR DIN STANDARD SUCTION & DISCHARGE SPOOL FLANGES AVAILABLE**

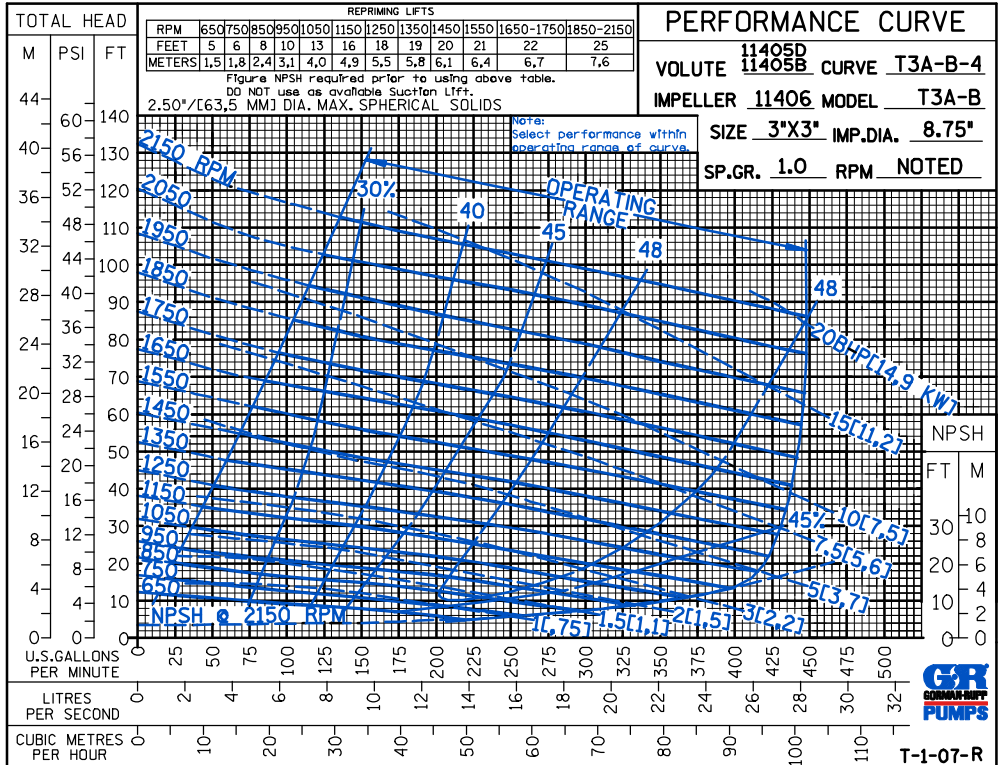

**THE GORMAN-RUPP COMPANY • MANSFIELD, OHIO**

GORMAN-RUPP OF CANADA LIMITED • ST. THOMAS, ONTARIO, CANADA

Specifications Subject to Change Without Notice

Printed in U.S.A.

CDS

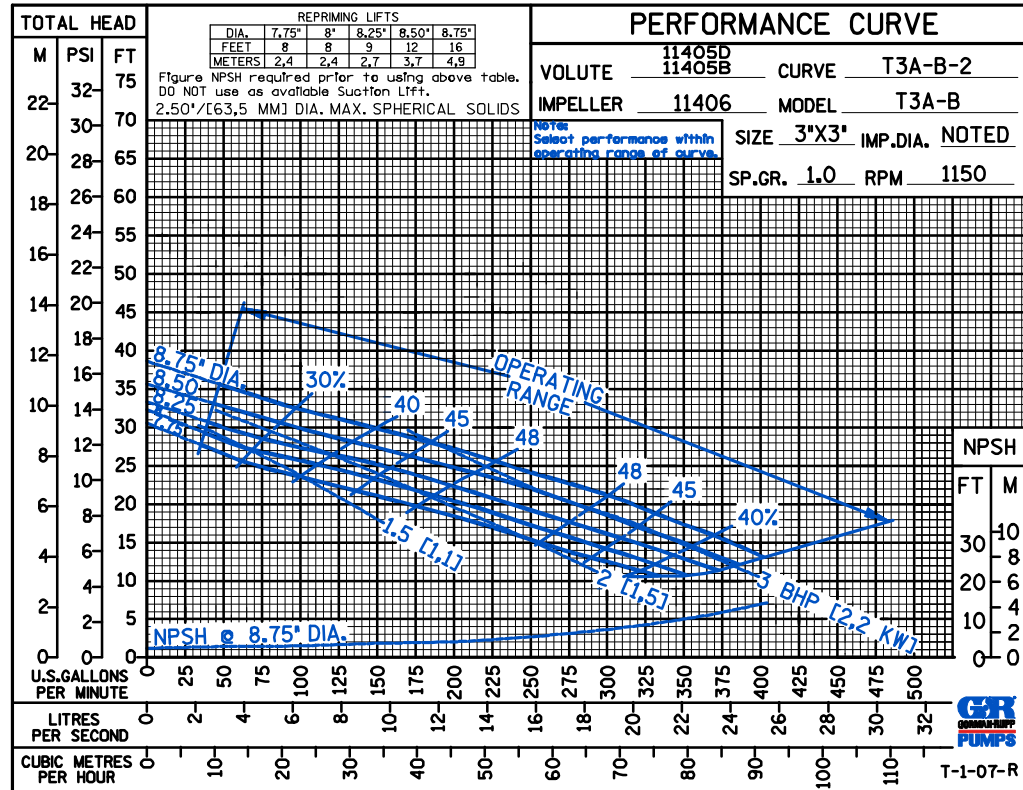
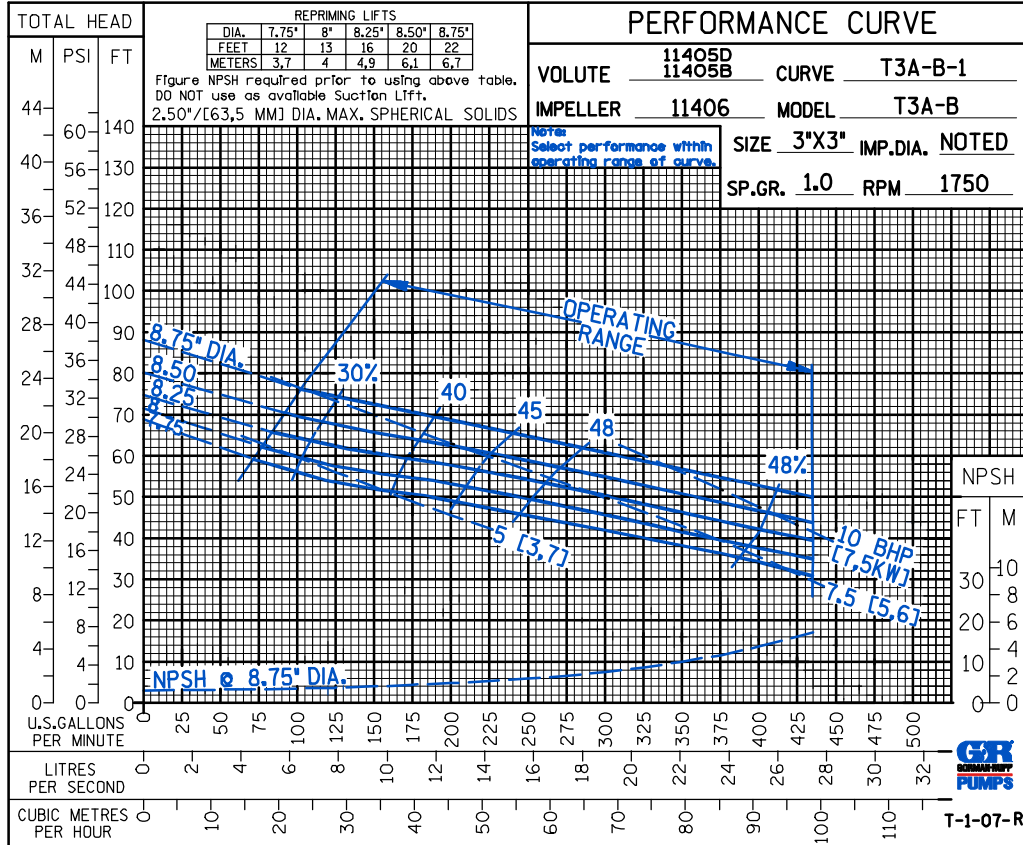

THE GORMAN-RUPP COMPANY • MANSFIELD, OHIO

GORMAN-RUPP OF CANADA LIMITED • ST. THOMAS, ONTARIO, CANADA

Specifications Subject to Change Without Notice

Printed in U.S.A.

CDS

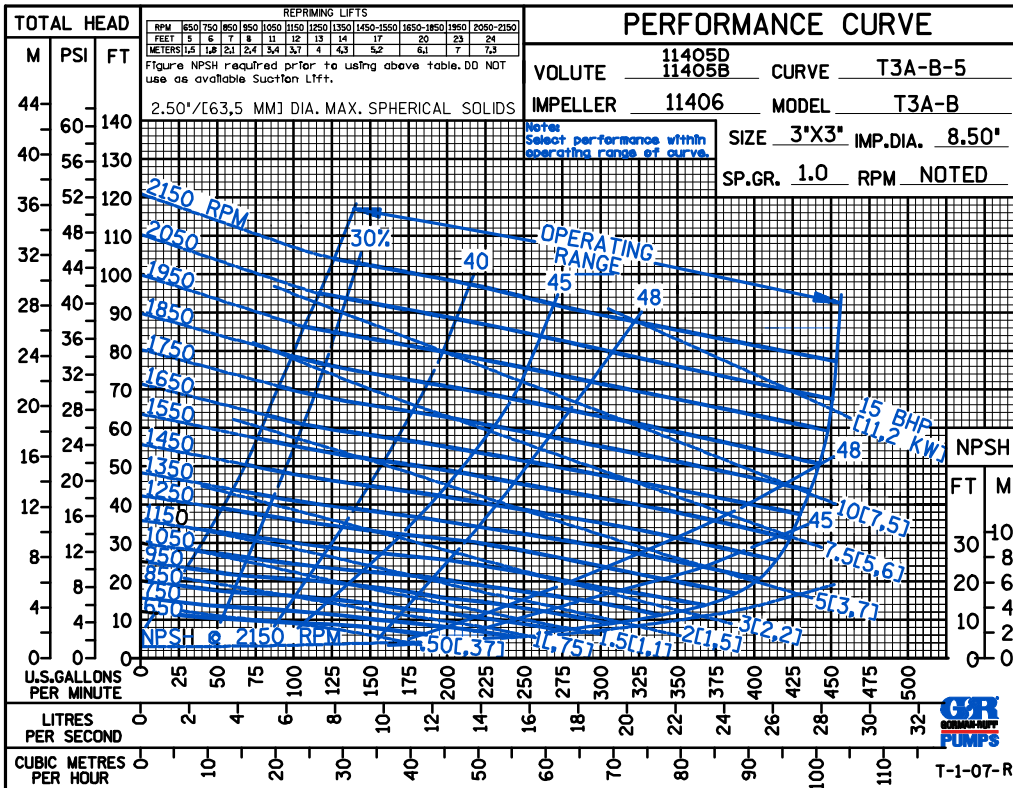
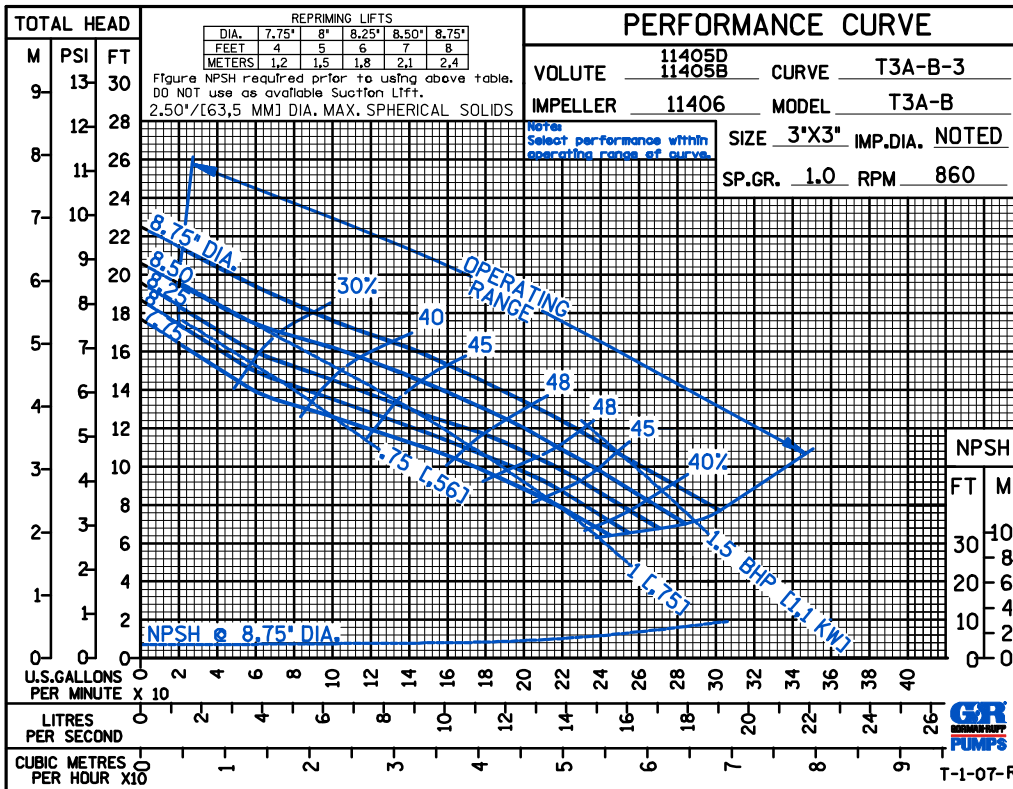

THE GORMAN-RUPP COMPANY • MANSFIELD, OHIO

GORMAN-RUPP OF CANADA LIMITED • ST. THOMAS, ONTARIO, CANADA

Specifications Subject to Change Without Notice

Printed in U.S.A.

CDS

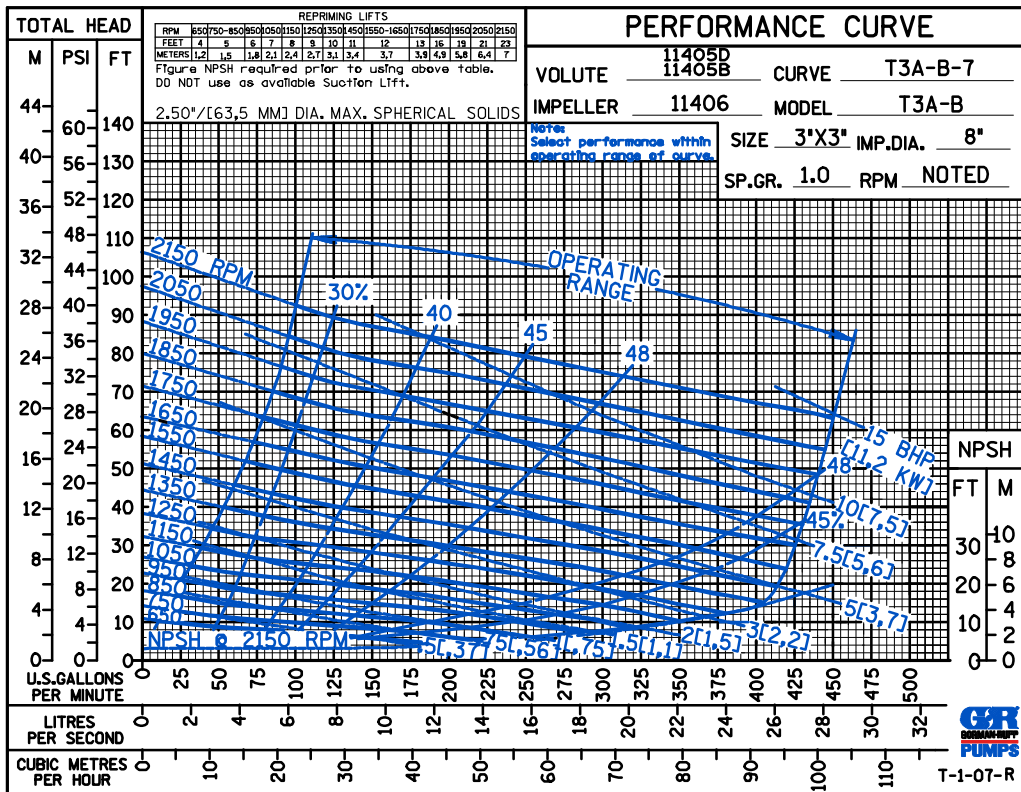
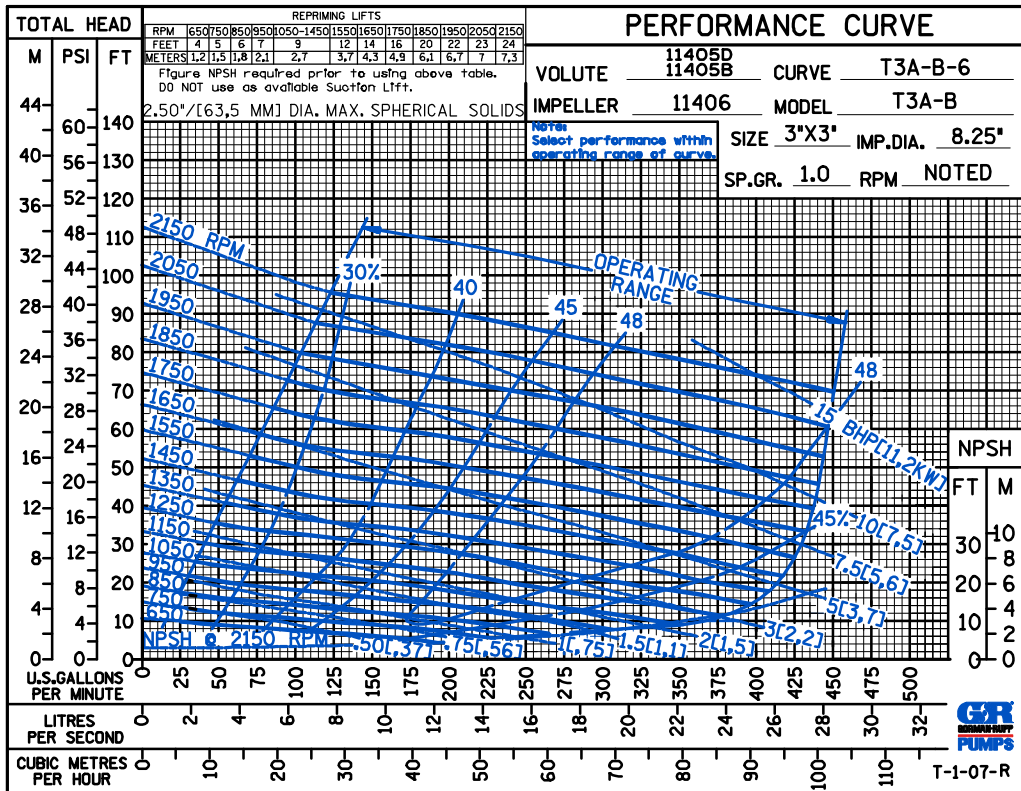

THE GORMAN-RUPP COMPANY • MANSFIELD, OHIO

GORMAN-RUPP OF CANADA LIMITED • ST. THOMAS, ONTARIO, CANADA

Specifications Subject to Change Without Notice

Printed in U.S.A.

CDS

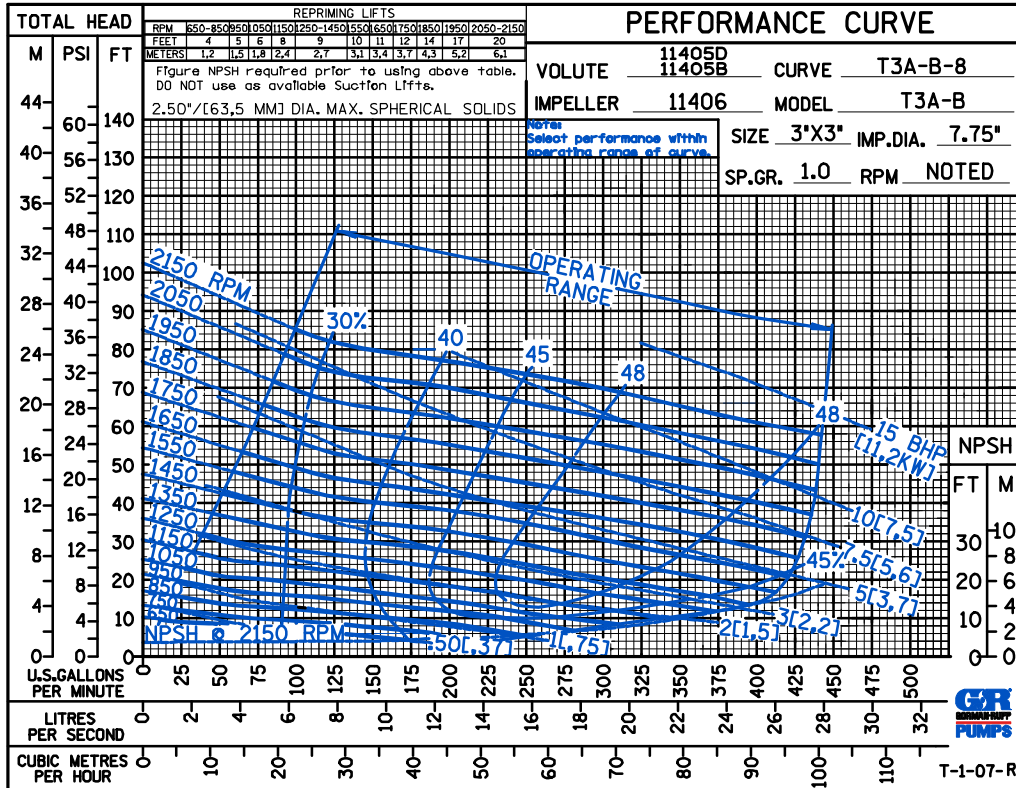

50 HERTZ

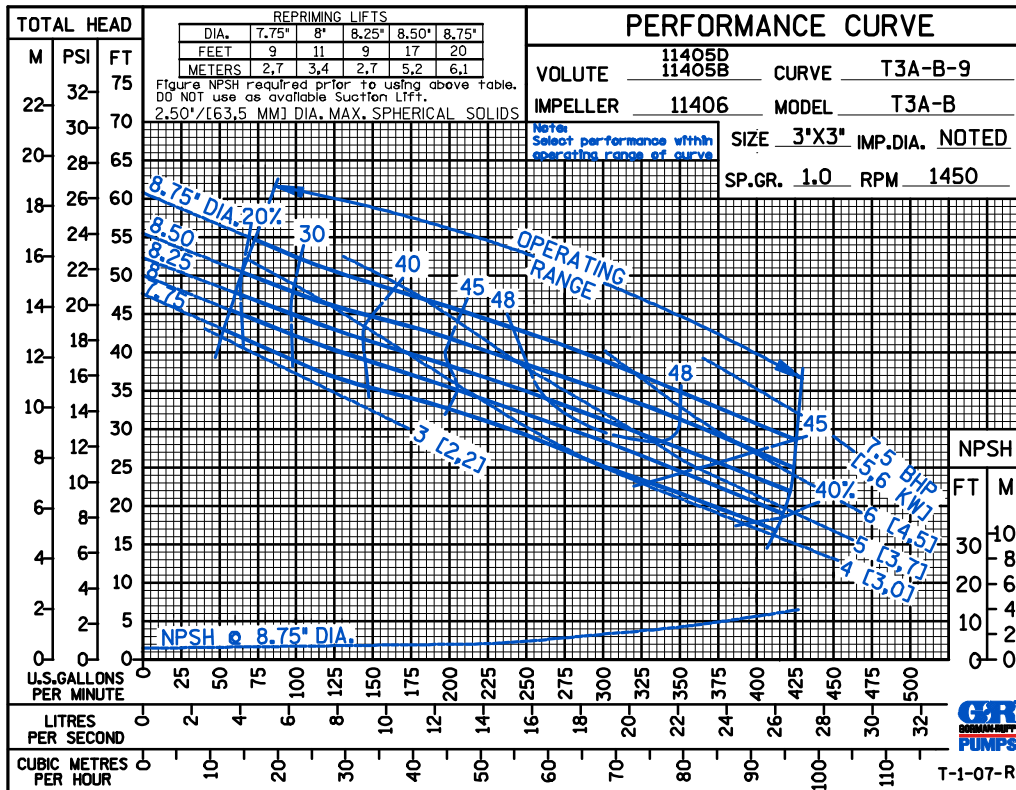

THE GORMAN-RUPP COMPANY • MANSFIELD, OHIO

GORMAN-RUPP OF CANADA LIMITED • ST. THOMAS, ONTARIO, CANADA

Specifications Subject to Change Without Notice

Printed in U.S.A.

CDS

50 HERTZ

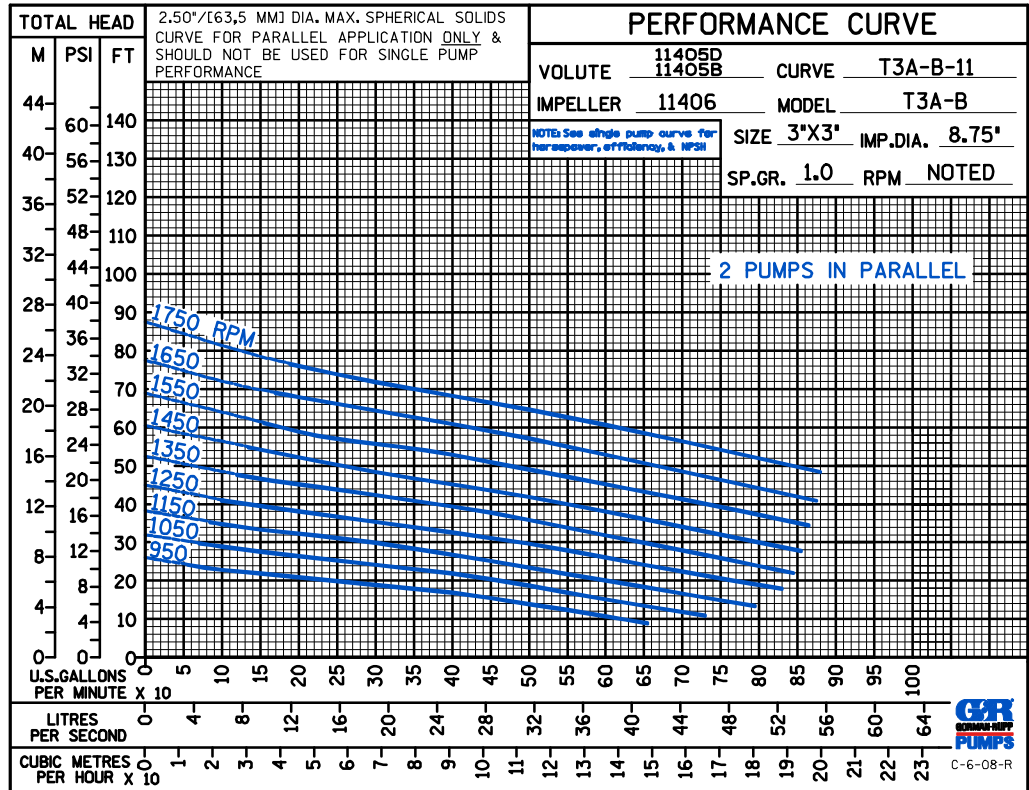
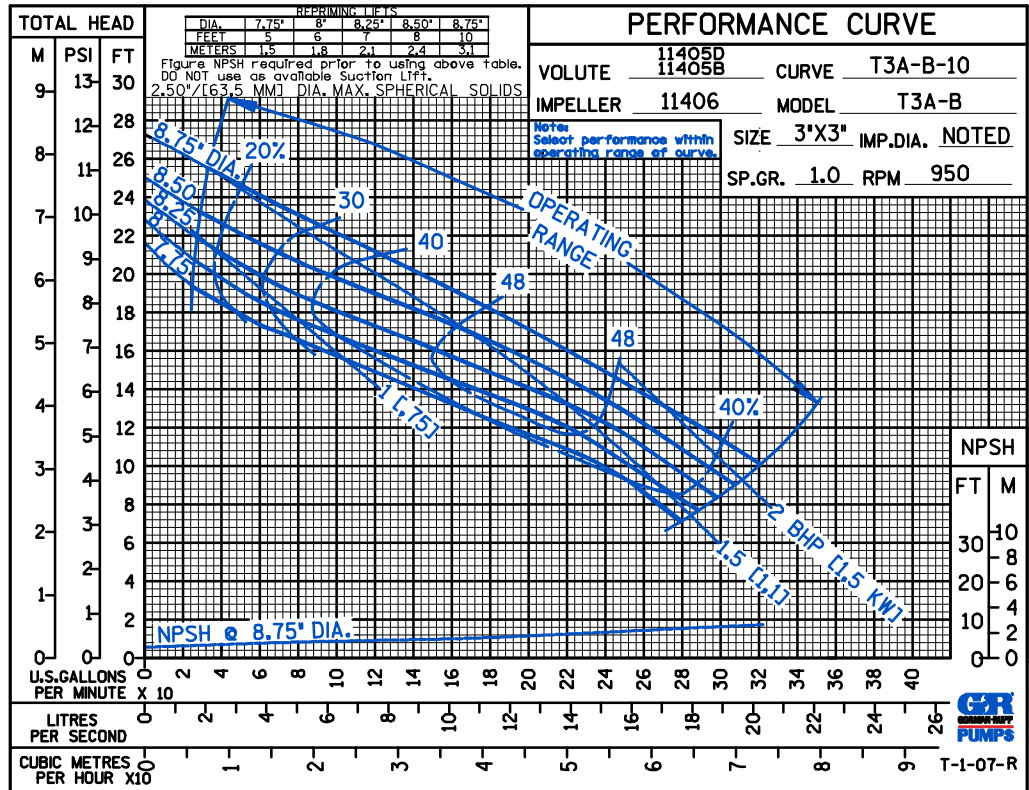

THE GORMAN-RUPP COMPANY • MANSFIELD, OHIO

GORMAN-RUPP OF CANADA LIMITED • ST. THOMAS, ONTARIO, CANADA

Specifications Subject to Change Without Notice

Printed in U.S.A.

CDS

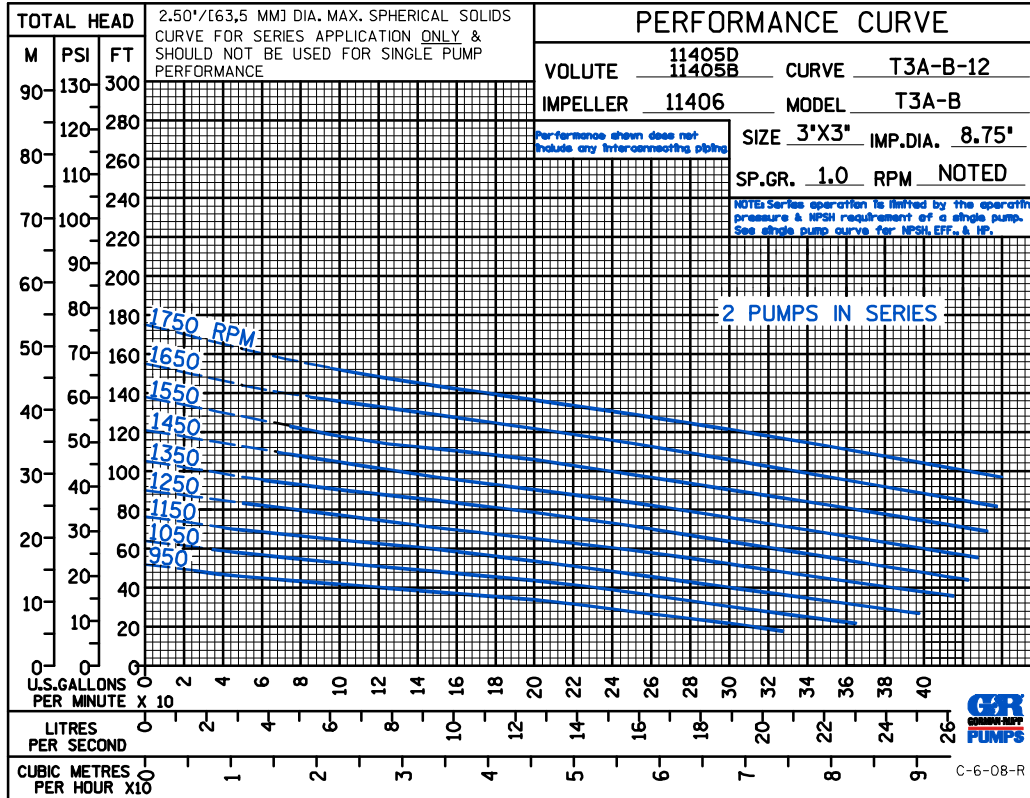

THE GORMAN-RUPP COMPANY • MANSFIELD, OHIO

GORMAN-RUPP OF CANADA LIMITED • ST. THOMAS, ONTARIO, CANADA

Specifications Subject to Change Without Notice

Printed in U.S.A.