

CDS

Self Priming Centrifugal Pump

**Super
T SERIES**

VARIOUS PATENTS APPLY

Model T6A75S-B**Size 6" x 6"****PUMP SPECIFICATIONS****Size:** 6" x 6" (152 mm x 152 mm) NPT - Female.**Casing:** G-R Hard Iron.

Maximum Operating Pressure 79 psi (545 kPa).*

Semi-Open Type, Two Vane Impeller: G-R Hard Iron.

Handles 3" (76,2 mm) Diameter Spherical Solids.

Impeller Shaft: Alloy Steel 4150.**Shaft Sleeve:** Alloy Steel 4130.**Replaceable Wear Plate:** Hardened Alloy Steel.**Removable Adjustable Cover Plate:** Gray Iron 30; 62 lbs. (28 kg).**Flap Valve:** Neoprene w/Nylon and Steel Reinforcing.**Seal Plate:** G-R Hard Iron.**Bearing Housing:** Gray Iron 30.**Radial Bearing:** Open Single Row Ball.**Thrust Bearing:** Open Double Row Ball.**Bearing and Seal Cavity Lubrication:** SAE 30 Non-Detergent Oil.**Flanges:** Gray Iron 30.**Gaskets:** Buna-N, Compressed Synthetic Fibers, PTFE, Vegetable Fiber, Cork, and Rubber.**O-Rings:** Buna-N.**Hardware:** Standard Plated Steel.**Brass Pressure Relief Valve.****Bearing and Seal Cavity Oil Level Sight Gauges.****Optional Equipment:** Metal Bellows Seal. Automatic Air

Release Valve. 120V/240V Casing Heater. High Pump

Temperature Shutdown Kit. Self-Cleaning Wear Plate. High

Chrome Cast Iron Impeller.

Gray Iron 30 Suction and Discharge Spool Flanges:

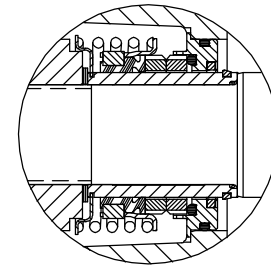
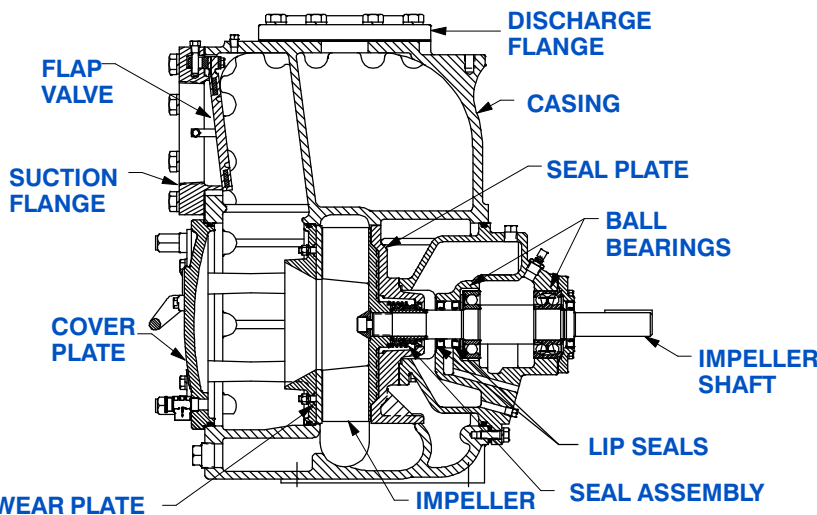
6" ASA (**Specify Model T6A75S-B /F**).150 mm DIN 2527 (PN16) (**Specify Model T6A75S-B /FM**).**Consult Factory for Applications Exceeding
Maximum Pressure and/or Temperature Indicated.***Shown with Optional Suction & Discharge Spool Flanges (Available in ASA or DIN Standard Sizes).****SEAL DETAIL**

Cartridge Type, Mechanical, Oil-Lubricated, Double Floating, Self-Aligning. Silicon Carbide Rotating and Stationary Faces. Stainless Steel 316 Stationary Seat. Fluorocarbon Elastomers (DuPont Viton® or Equivalent). Stainless Steel 18-8 Cage and Spring. Maximum Temperature of Liquid Pumped, 160°F (71°C).*

**THE GORMAN-RUPP COMPANY • MANSFIELD, OHIO**

GORMAN-RUPP OF CANADA LIMITED • ST. THOMAS, ONTARIO, CANADA

www.grpumps.com

Specifications Subject to Change Without Notice

Printed in U.S.A.

Specification Data

SECTION 55, PAGE 2242

APPROXIMATE DIMENSIONS and WEIGHTS

NET WEIGHT: 865 LBS. (392 KG.)*
SHIPPING WEIGHT: 920 LBS. (417 KG.)*
EXPORT CRATE: 32.5 CU. FT. (0.92 CU. M.)
***ADD 25 LBS. (11,3 KG.) W/EACH SPOOL FLANGE**

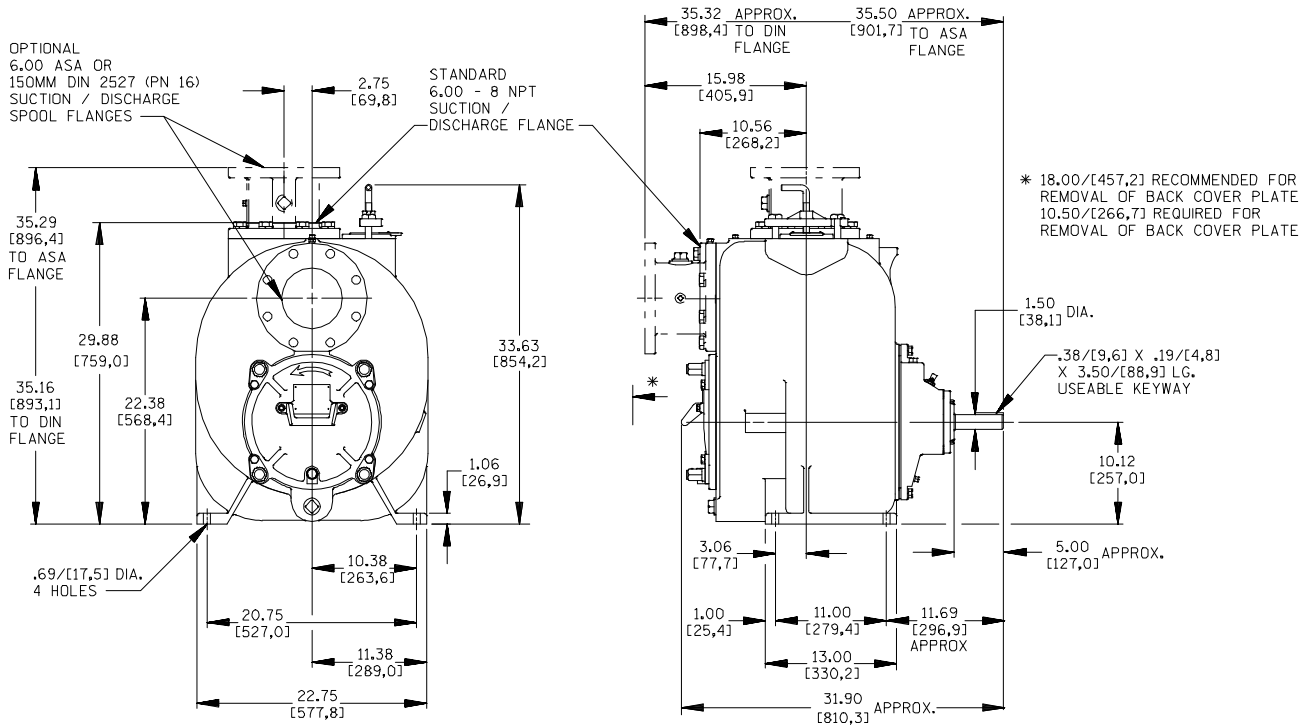

OPTIONAL ASA OR DIN STANDARD SUCTION & DISCHARGE SPOOL FLANGES AVAILABLE

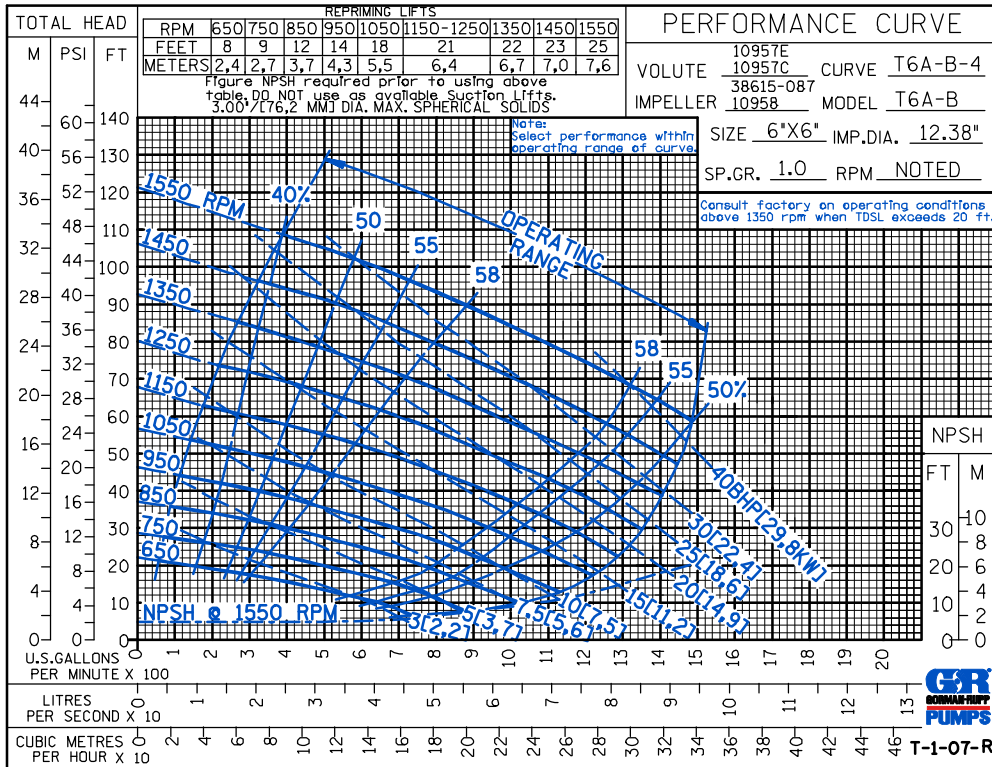

THE GORMAN-RUPP COMPANY • MANSFIELD, OHIO

GORMAN-RUPP OF CANADA LIMITED • ST. THOMAS, ONTARIO, CANADA

Specifications Subject to Change Without Notice

Printed in U.S.A.

CDS

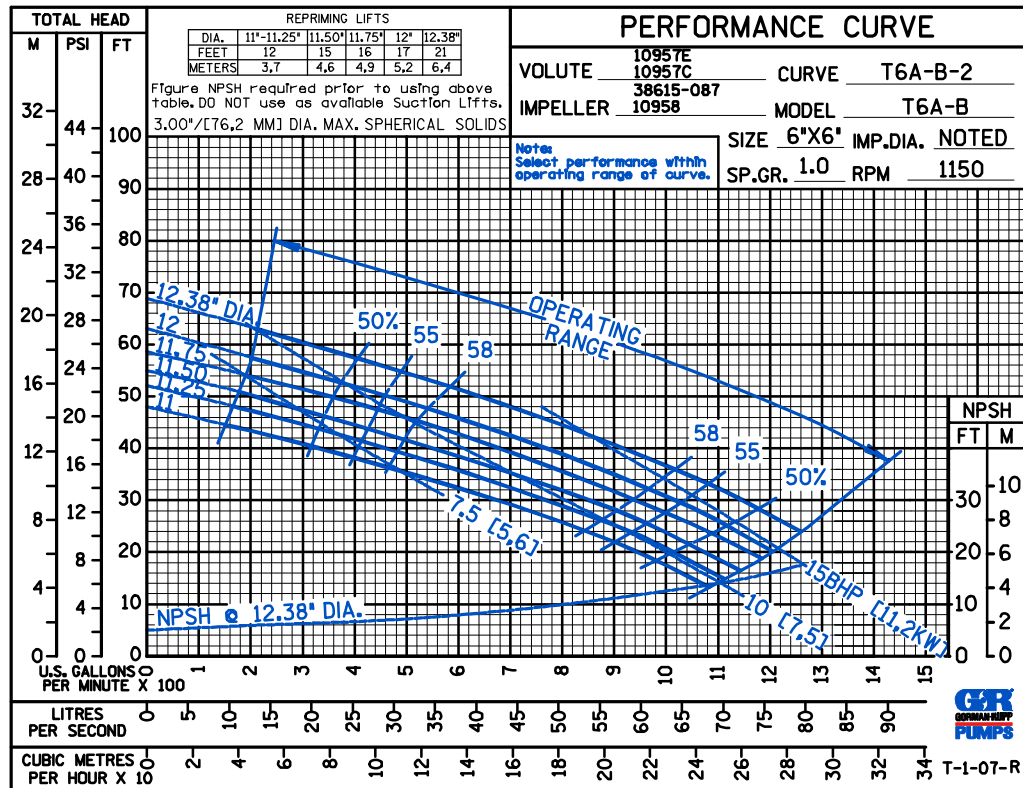
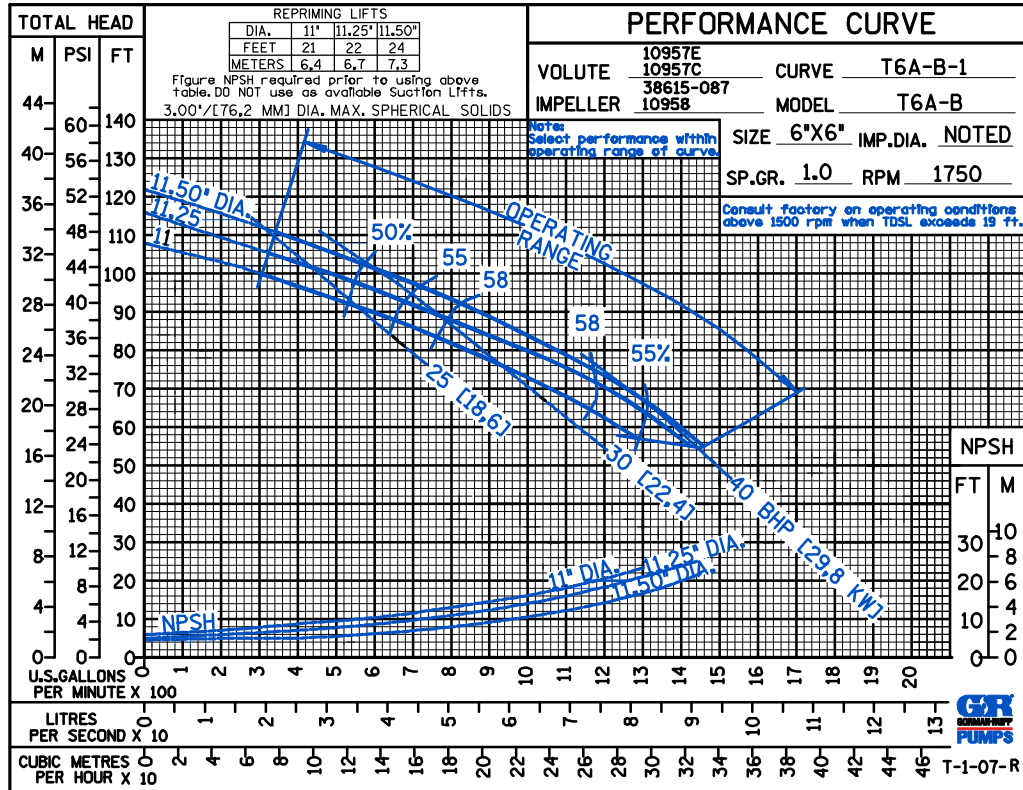

THE GORMAN-RUPP COMPANY • MANSFIELD, OHIO

GORMAN-RUPP OF CANADA LIMITED • ST. THOMAS, ONTARIO, CANADA

Specifications Subject to Change Without Notice

Printed in U.S.A.

CDS

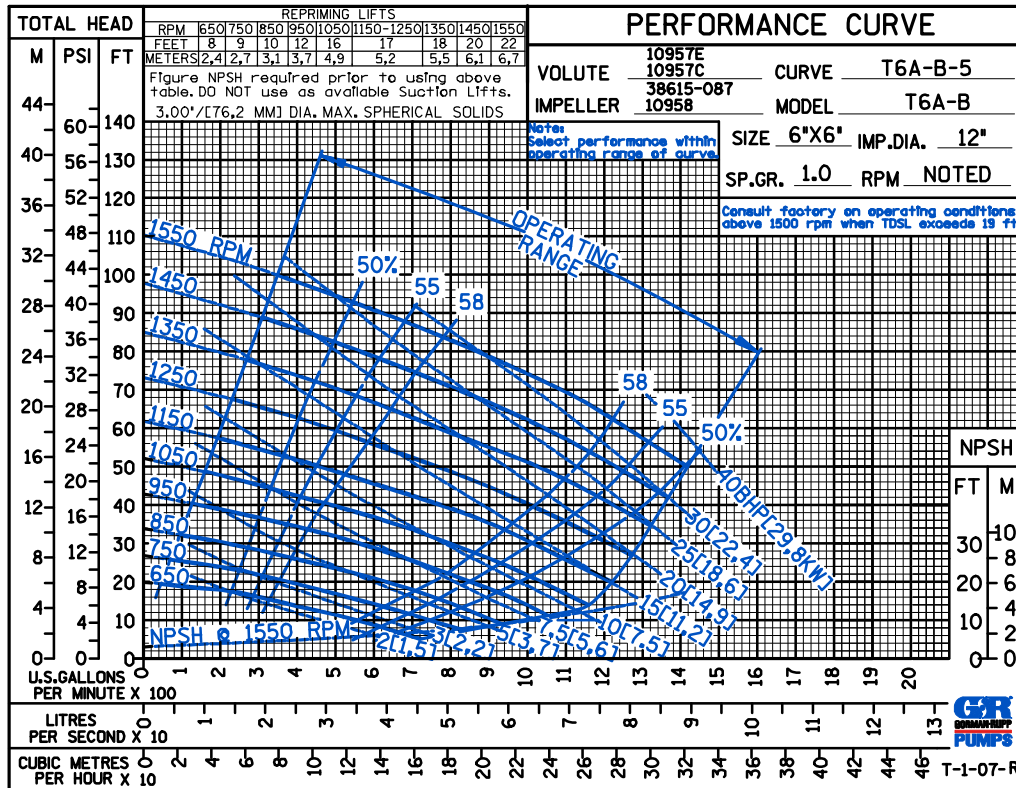
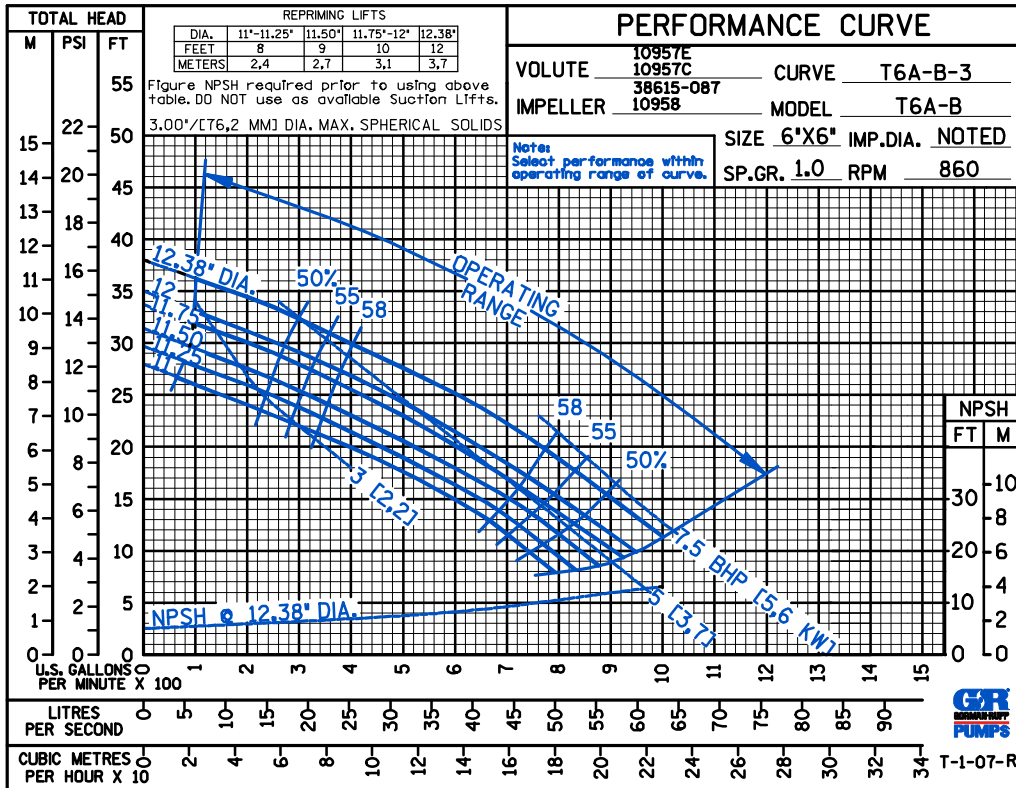

THE GORMAN-RUPP COMPANY • MANSFIELD, OHIO

GORMAN-RUPP OF CANADA LIMITED • ST. THOMAS, ONTARIO, CANADA

Specifications Subject to Change Without Notice

Printed in U.S.A.

CDS

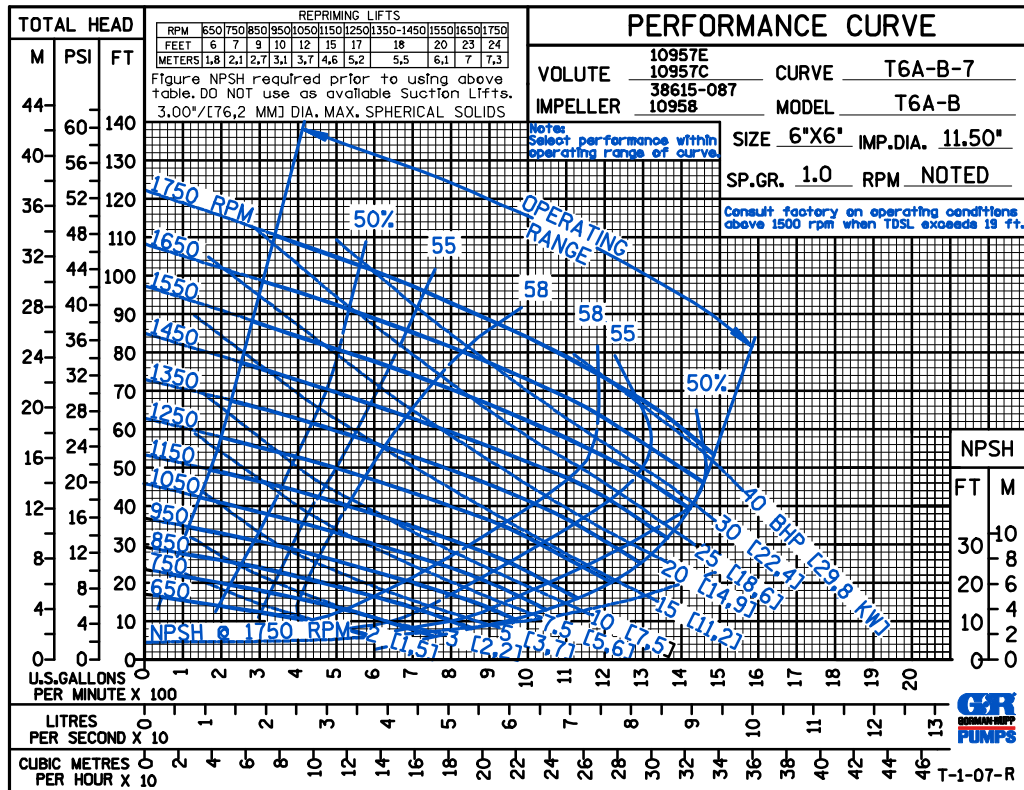
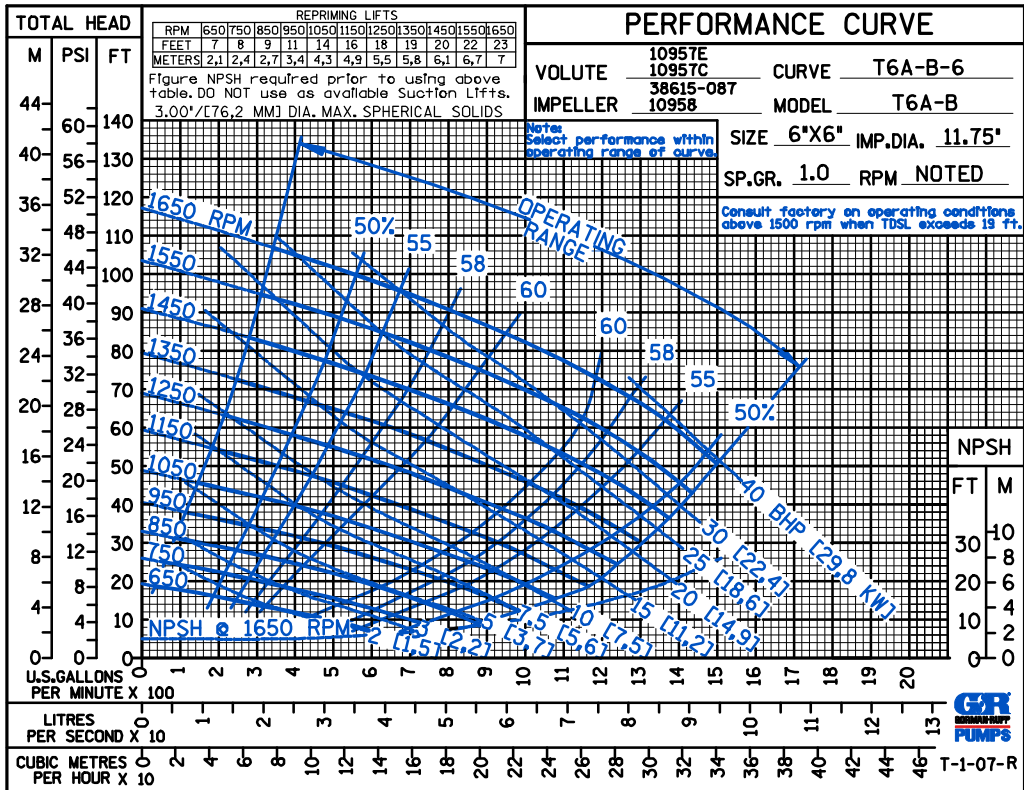

THE GORMAN-RUPP COMPANY • MANSFIELD, OHIO

GORMAN-RUPP OF CANADA LIMITED • ST. THOMAS, ONTARIO, CANADA

Specifications Subject to Change Without Notice

Printed in U.S.A.

CDS

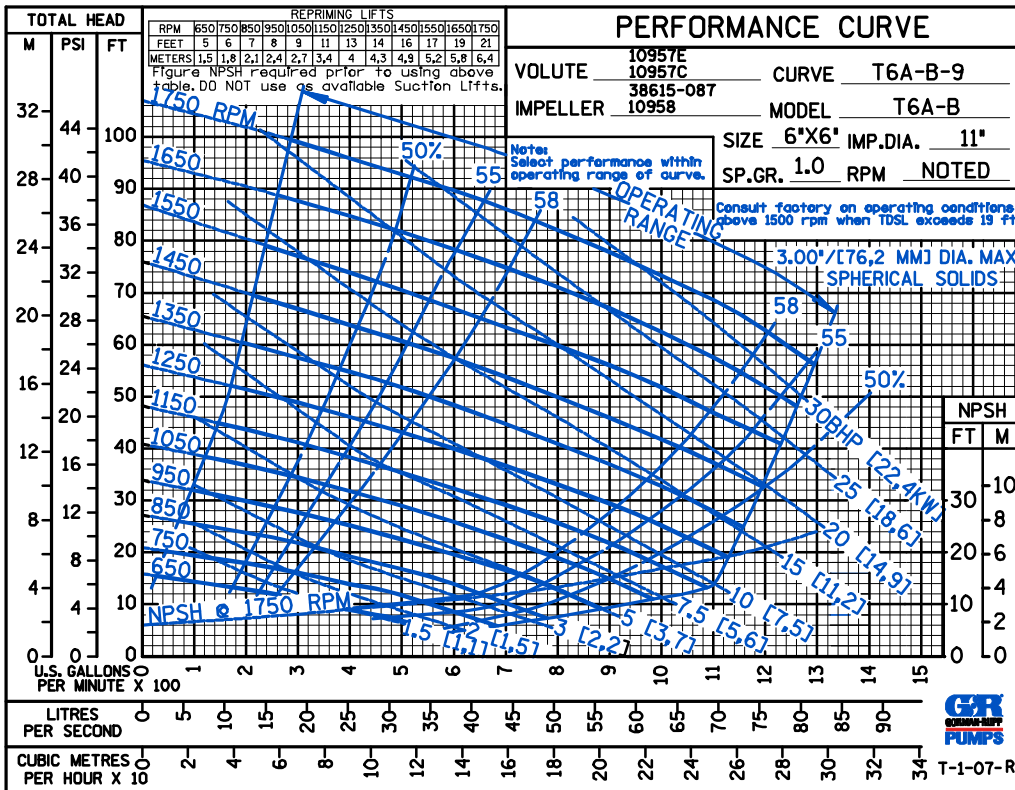
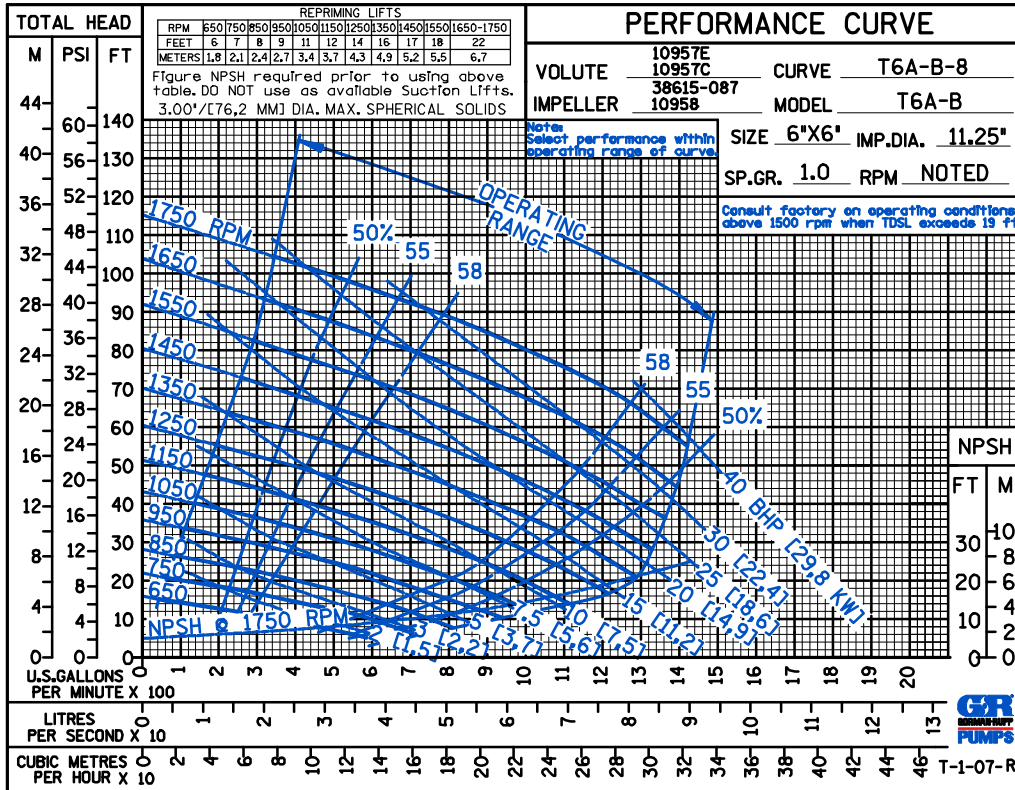

THE GORMAN-RUPP COMPANY • MANSFIELD, OHIO

GORMAN-RUPP OF CANADA LIMITED • ST. THOMAS, ONTARIO, CANADA

Specifications Subject to Change Without Notice

Printed in U.S.A.

CDS

50 HERTZ

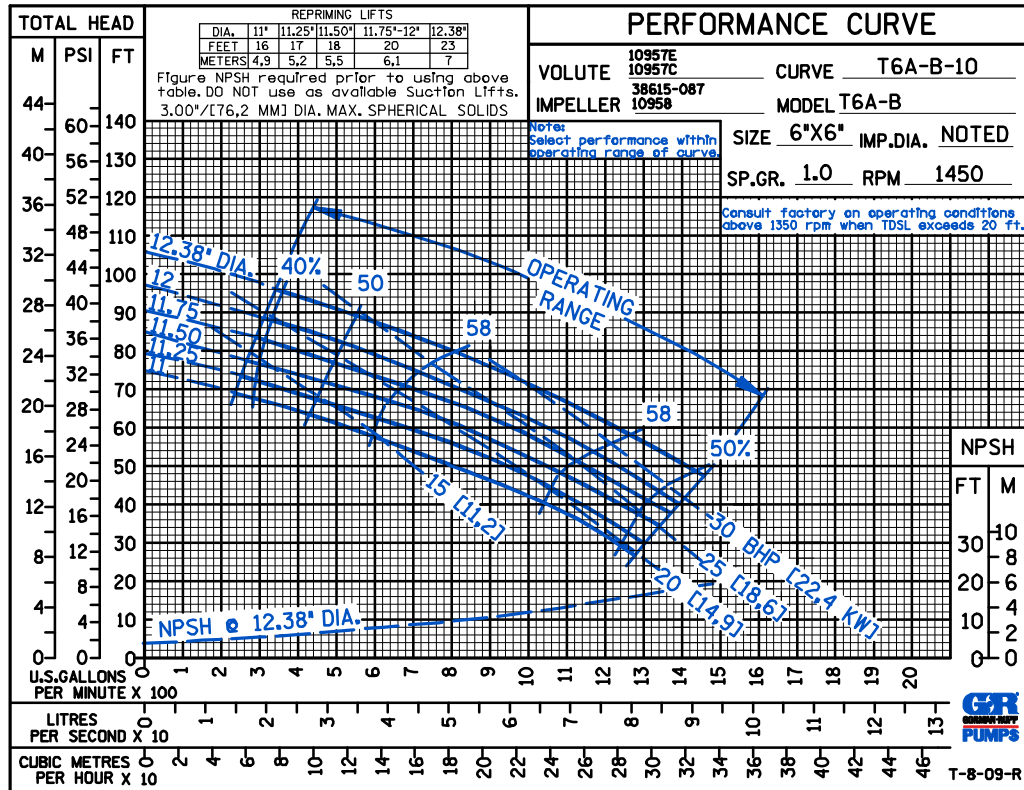

50 HERTZ

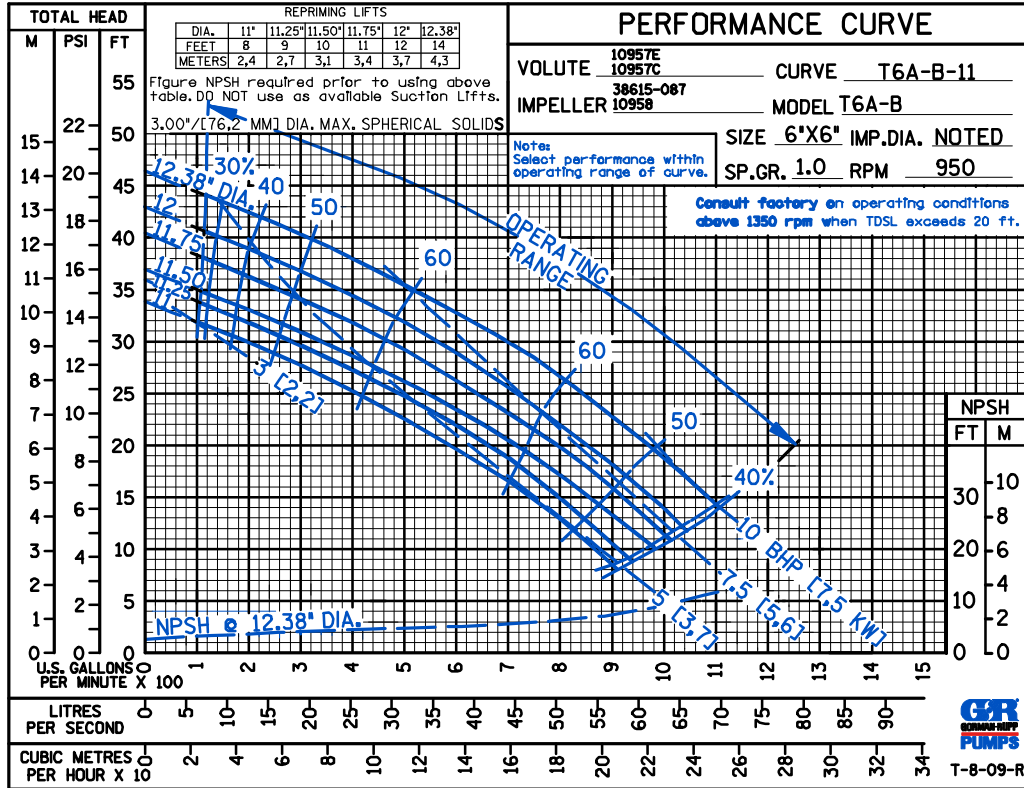

THE GORMAN-RUPP COMPANY • MANSFIELD, OHIO

GORMAN-RUPP OF CANADA LIMITED • ST. THOMAS, ONTARIO, CANADA

Specifications Subject to Change Without Notice

Printed in U.S.A.

D S

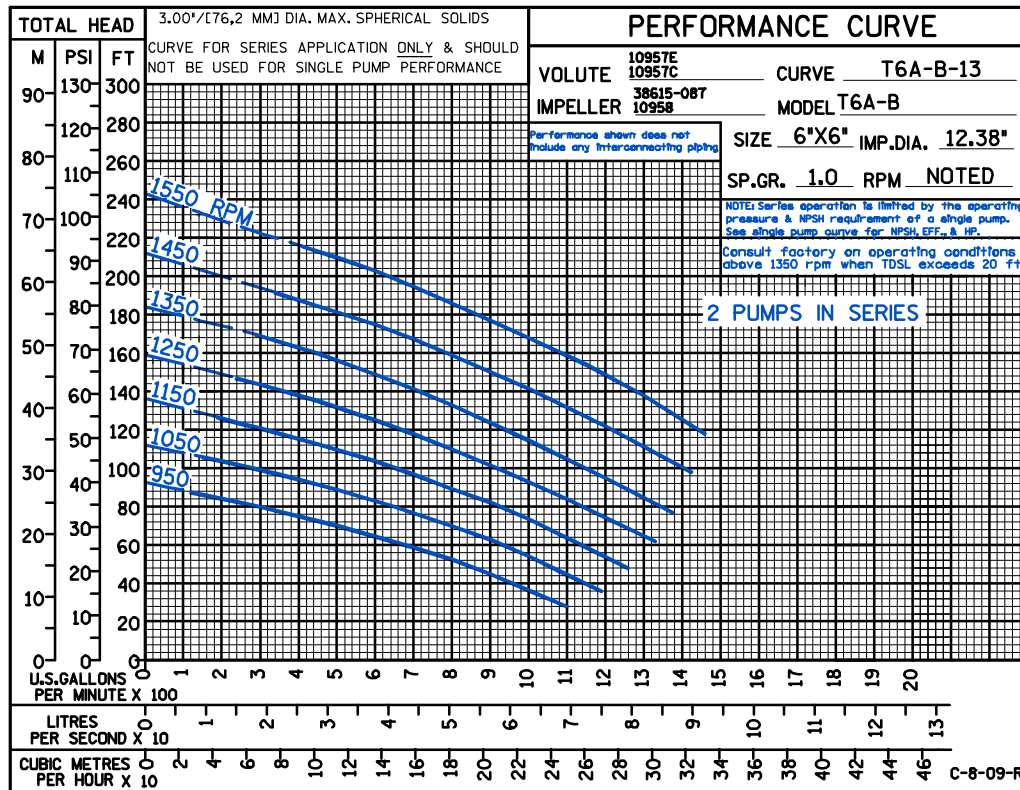
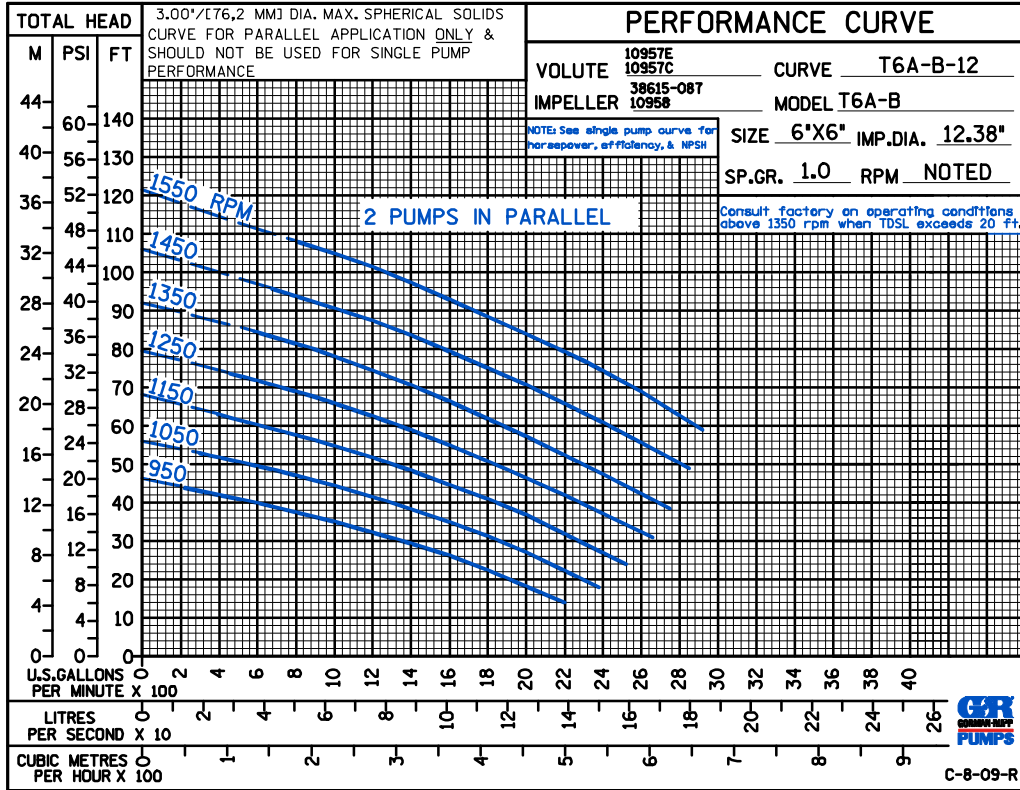

THE GORMAN-RUPP COMPANY • MANSFIELD, OHIO

GORMAN-RUPP OF CANADA LIMITED • ST. THOMAS, ONTARIO, CANADA

Specifications Subject to Change Without Notice

Printed in U.S.A.